

AD41D, D41D, TAM41D, TMD41D

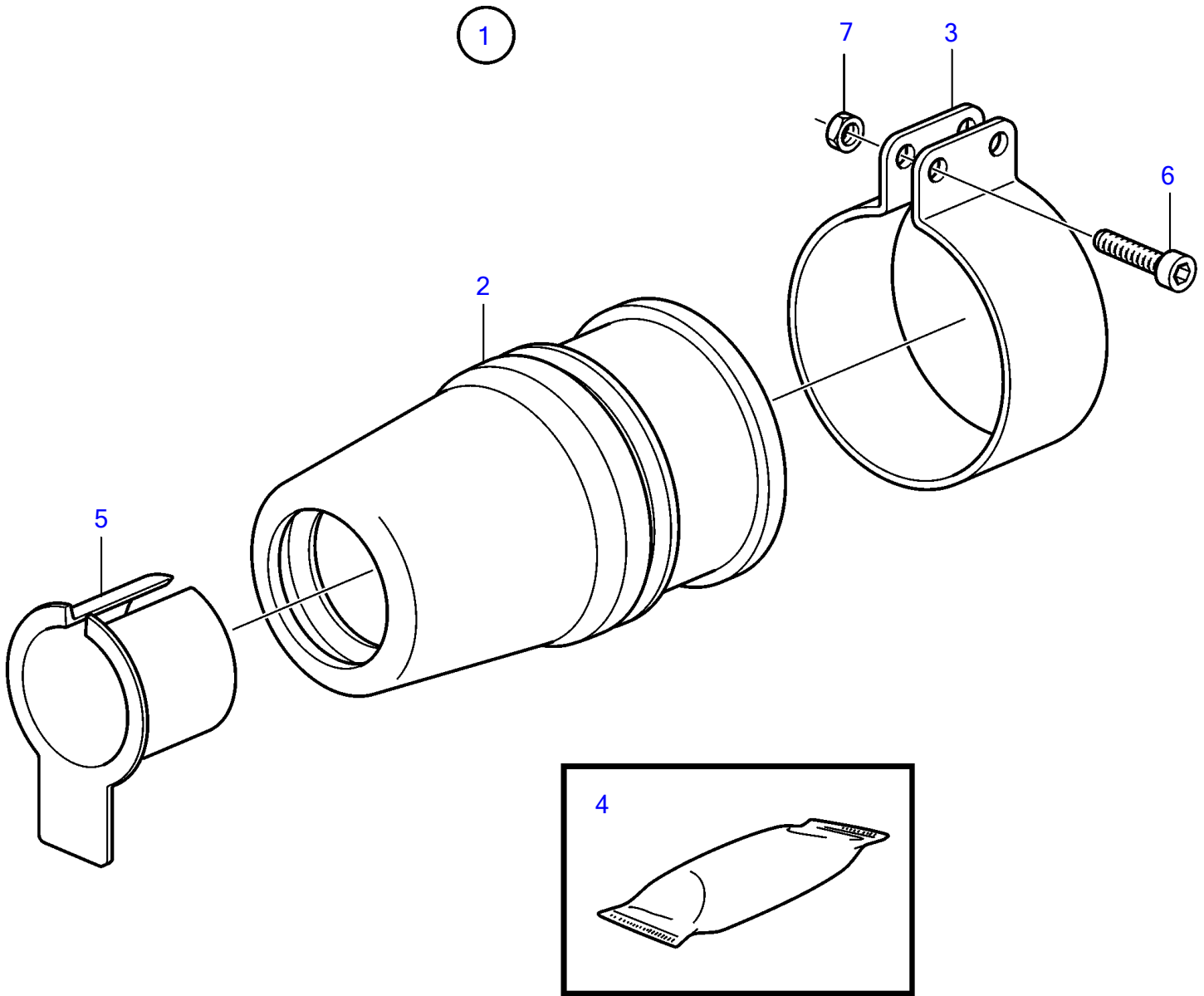

6147

AD41D, D41D, TAMD41D, TMD41D

REF	PART NO.	QTY	DESCRIPTION	SEE SEC.	NOTES
1	828526	1	Sealing		
			Bulletin P-44-6-1	P-44-6-1-EN	Rubber Stuffing Box
2		1	• Sealing strip		
3	828528	1	• Clamp		
4	828250	1	• Lubricating grease		
			Bulletin P-18-4-6	P-18-4-6-EN	Water resistant grease for grease gun
5		1	• Sleeve		
6	963684	2	• Hex. socket screw		
7	966170	2	• Lock nut		