

TAMD41D

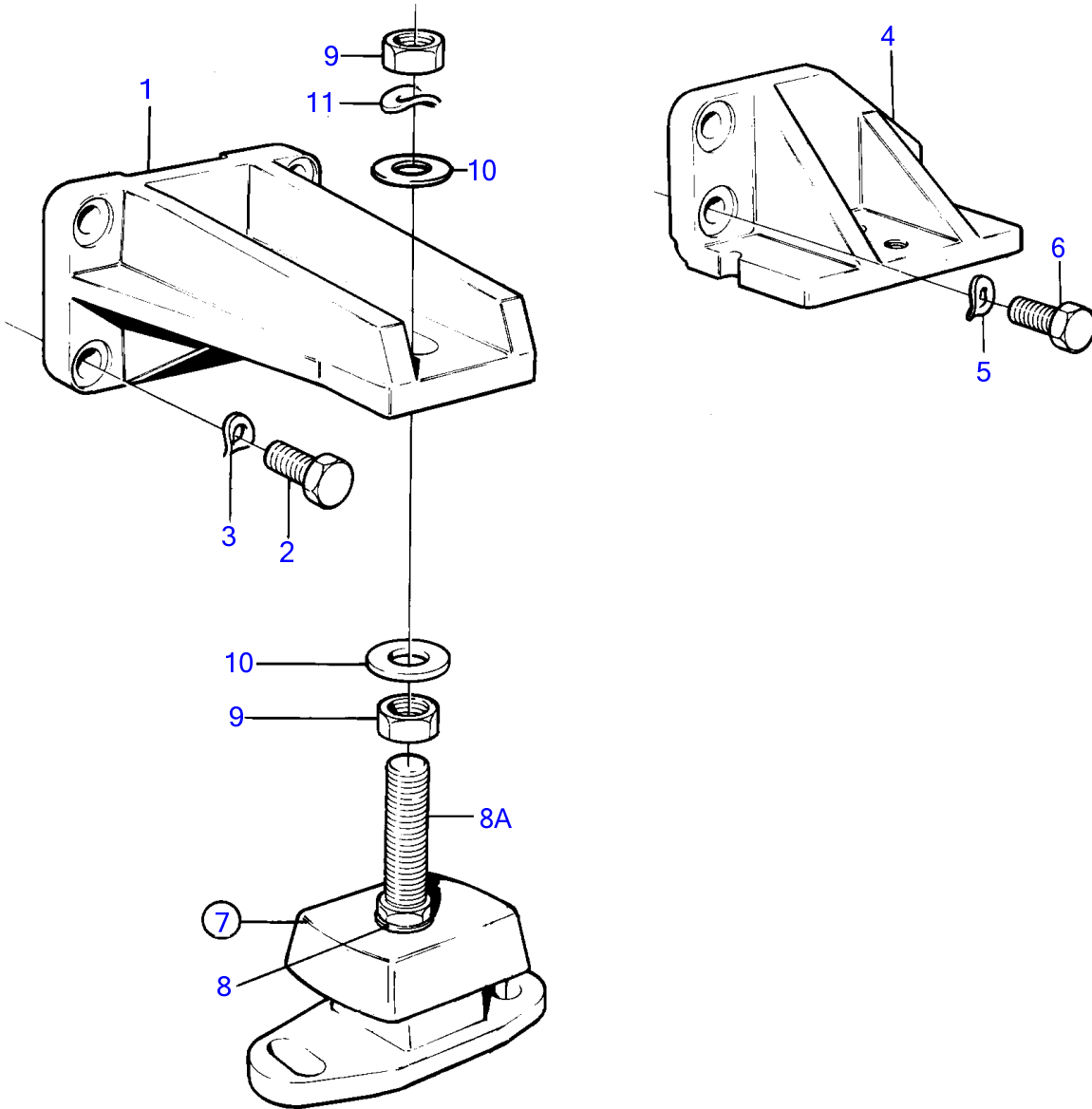

11388

TAMD41D

REF	PART NO.	QTY	DESCRIPTION	NOTES
1	860953	2	Engine bracket	With hole for M18 adjusting bolt.
2	965192	8	Flange screw	L=40mm
3	940280	8	Spring washer	
4	860952	1	Engine bracket	With hole for M18 adjusting bolt., P, rear
	860954	1	Engine bracket	With hole for M18 adjusting bolt., S.B, rear
5	940280	4	Spring washer	
	955897	2	Washer	
6	966343	3	Flange screw	L=35mm, S.B
	966343	1	Flange screw	L=35mm, P
	965226	2	Flange screw	L=45mm, p
7	861302	4	Rubber cushion	
8	955900	4	• Washer	
8A	860950	4	• Adjusting screw	M18
9	955806	8	Hexagon nut	
10	955901	4	Washer	D=34mm
	978991	4	Washer	D=40mm
11	941913	4	Spring washer	