

TAMD41D, TMD41D

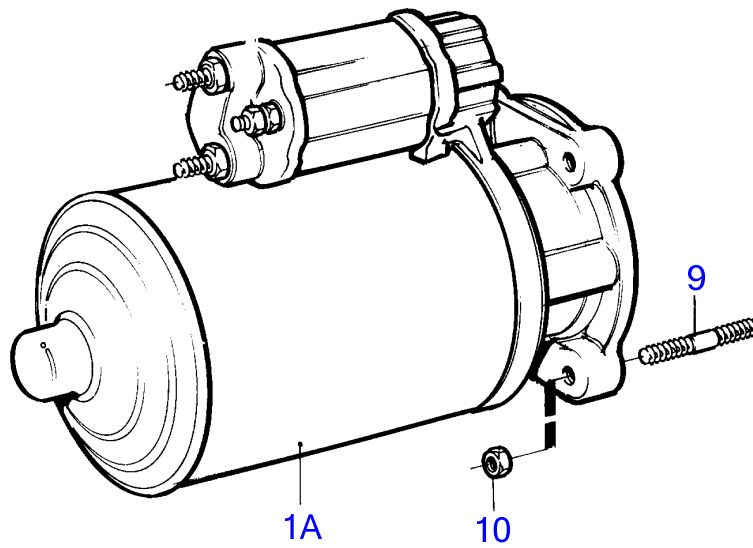
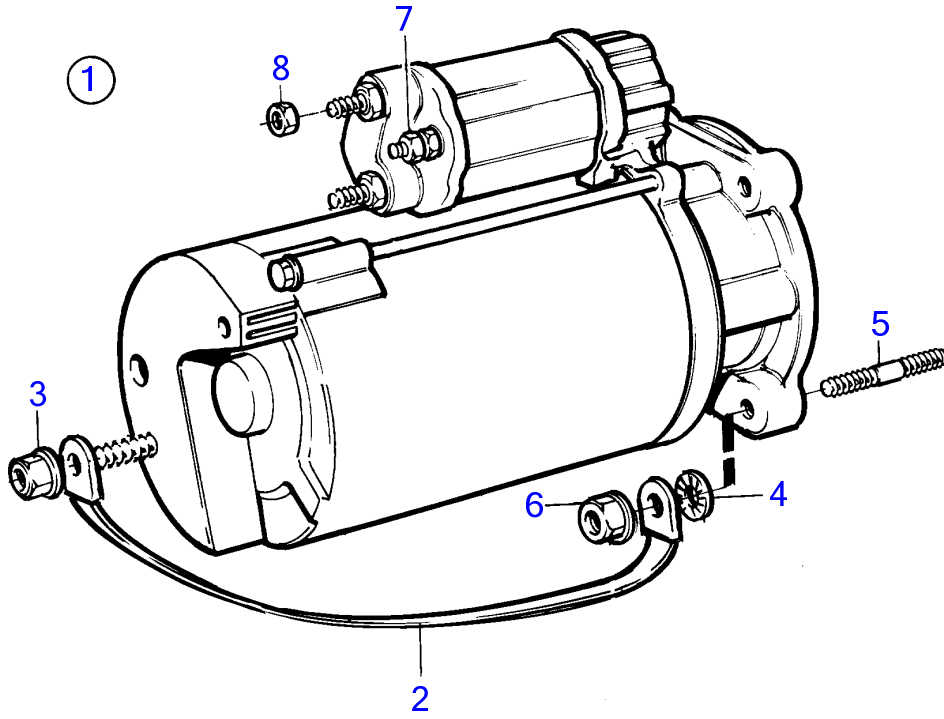

11119

TAMD41D, TMD41D

REF	PART NO.	QTY	DESCRIPTION	SEE SEC.	NOTES
1	859252	1	Starter motor		12V
			.		
			.	583	
	3581774	1	Starter motor		
	3803386	1	Starter motor, exch, exch		
			.		
			.	4930	
1A	838987	1	Starter motor		24V
1			.		
			.	968	
2	968048	1	Chassis ground cable		
3	945408	1	Flange nut		
4	945987	1	Toothed washer		
5	953067	2	Stud		L=45mm
	953069	1	Stud		L=50mm
6	971095	3	Flange nut		
7	965483	1	Flange nut		
8	945408	1	Flange nut		
9	953067	2	Stud		L=45mm
	953069	1	Stud		L=50mm
10	971095	3	Flange nut		