

 Loctite PST Pipe Sealant (92-809822)

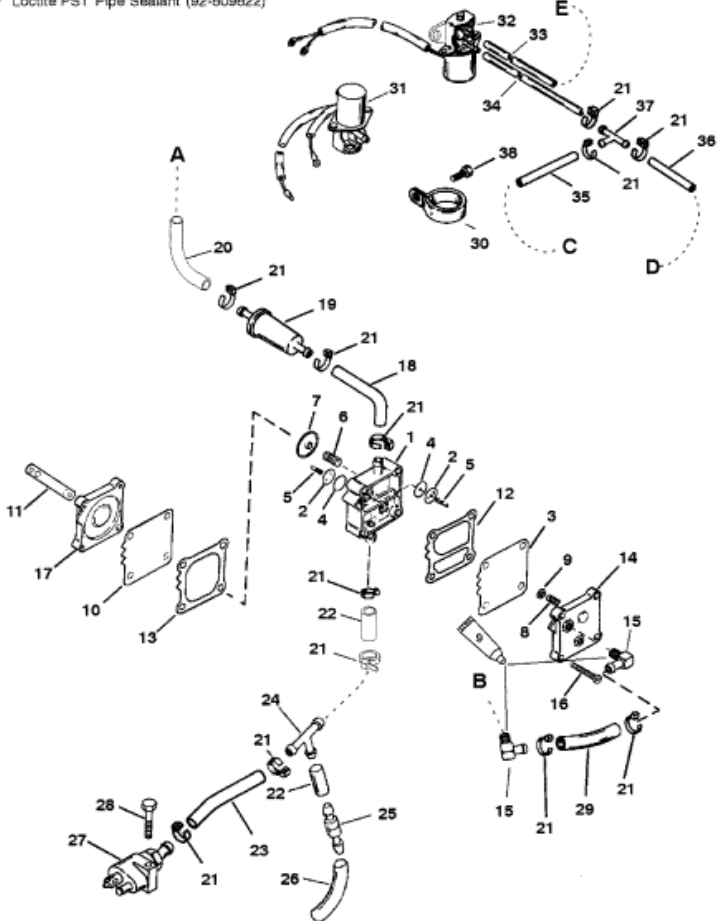

A= TO TOP CARBURETOR,
 B= TO CRANKCASE
 C = TO OIL PUMP FITTING (REF. #37 ON "INDUCTION MANIFOLD AND REED BLOCK")
 D = TO INTAKE MANIFOLD FITTING (REF. #14 ON "CRANKSHAFT, PISTONS & CON. RODS"),
 E = TO FITTING (REF. #16 ON "CARBURETOR")

Parts List

Ref	Class	Part	Description	Qty	Comment	Footnote
-		14360A43	FUEL PUMP ASSEMBLY	1		
1		NSS	FUEL PUMP	1		7
2	21	42990A10	DIAPHRAGM KIT	2		5,8
3		NSS	DIAPHRAGM	1		7,8
4		NSS	RUBBER CHECK VALVE	2		7,8
5		NSS	RETAINER	2		7,8
6		NSS	SPRING	1		7,8
7		NSS	CAP	1		7,8
8		NSS	SPRING	1		7,8
9		NSS	CAP	1		7,8
10		NSS	DIAPHRAGM	1		7,8
11	27	98769 1	GASKET	1		5,2,8
12		NSS	GASKET-BOOST	1		7,8
13		NSS	GASKET-PULSE	1		7,8
14		98775 2	PLATE	1		
15	22	43335	FITTING	2		2
16	10	821045 40	SCREW-FUEL PUMP	2		
16	10	821300 50	SCREW-FUEL PUMP TO CRANK	2		
17		14430 3	BASE	1		
18	32	831949	HOSE	1		
19	35	816296 1	FUEL FILTER	1		
20	32	830761	FUEL LINE	1		
21	54	816311	STA-STRAP	AR		10
22	32	830757 80	HOSE (1-1/4 IN.)	2		
23	32	830757 80	HOSE (1-1/4 IN.)	1		
24	22	818993	TEE	1		
25	22	818994 1	CHECK VALVE	1		
26	32	823813 35	HOSE (1-1/2 IN.)	1		
27	22	816856A 1	FUEL CONNECTOR	1		
28	10	40003 32	SCREW (M6 X 35)	1		
29	32	99128 78	HOSE (4-1/4 IN.)	1		2
30	54	63300 1	CLAMP	1	(NO STAMPING)	
30	54	63300 3	CLAMP	1	(STAMPED '3')	
31		42859 3	SOLENOID VALVE	1	(USE WITH NO STAMPING CLAMP)	
32	89	819503A 5	SOLENOID VALVE	1	(USE WITH STAMPED '3' CLAMP)	
33	32	99126 88	HOSE (9-1/2 IN.)	1	(MANUAL BUTTON MOUNTED L)	
33	32	99126 88	HOSE (8 IN.)	1	(MANUAL BUTTON MOUNTED L)	
34	32	99126 88	HOSE (3-1/4 IN.)	1	(MANUAL BUTTON MOUNTED L)	
34	32	99126 88	HOSE (4 IN.)	1	(MANUAL BUTTON MOUNTED L)	
35	32	99130122	HOSE (16 IN.)	1	(MANUAL BUTTON MOUNTED L)	
35	32	99130122	HOSE (14 IN.)	1	(MANUAL BUTTON MOUNTED L)	