



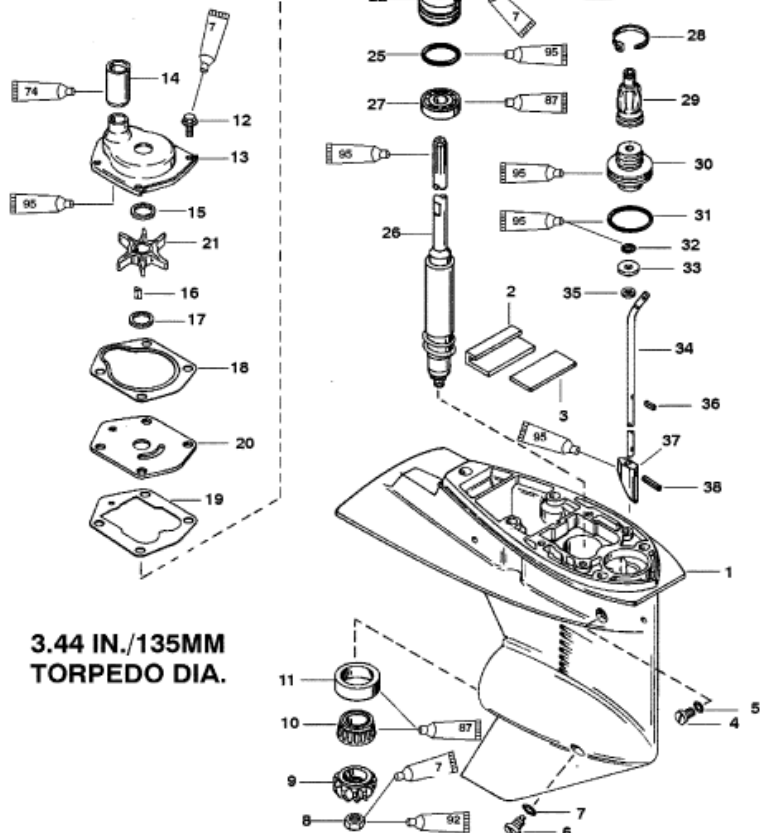

-  Loctite "271" Adhesive Sealant (92-809819)
-  Loctite "405" (Purchase Locally)
-  Super Duty Gear Lubricant (92-13783A24)
-  Loctite Primer "N" (92-59327-1)
-  2-4-C w/Teflon (92-825407A12)



**3.44 IN./135MM
TORPEDO DIA.**

Parts List						
Ref	Class	Part	Description	Qty	Comment	Footnote
-	1682	821306A24	GEAR HOUSING	1	(BLACK) S/N-0G442710 & UP 1.8	
-	1682	821306A25	GEAR HOUSING	1	(GRAY) S/N-0G442710 & UP 1.8	
-	1682	821306A17	GEAR HOUSING	1	(BLACK) S/N-0G442709 & BELOV	
-	1682	821306A18	GEAR HOUSING	1	(GRAY) S/N-0G442709 & BELOW	
1	1682	821306A12	GEAR HOUSING	1	(BASIC-BLACK)	
1	1682	821306A13	GEAR HOUSING	1	(BASIC-GRAY)	
2		818226A	SEAL/PLATE KIT	1		
3		NSS	PLATE	1	(PART OF 818226A1)	7
4	10	79953A	SCREW (.375-16 X .25)	1		
5	12	19183	WASHER-SEALING	1		
6	22	67892A	DRAIN SCREW	1	(MAGNETIC)	
7	12	19183	WASHER-SEALING	1		
8	11	55910	NUT	1		
9	43	822161	PINION GEAR (12 TEETH)	1	(1.83:1 GEAR RATIO)	
9	43	821326	PINION GEAR (13 TEETH)	1	(2:1 GEAR RATIO)	
10	31	821321A	BEARING ASSEMBLY-ROLLER	1		
11		NSS	CUP (PART OF 31-821321A2)	1		7
12	10	824832	SCREW (M6 X 16)	4		
13	46	821351A	WATER PUMP ASSEMBLY	1		
14		823547	SEAL-WATER TUBE	1		12,13
15	12	86645	WASHER	1		12,13
16	28	85119	KEY	1		12,13
17	12	86645	WASHER	1		12,13
18	27	822189	GASKET	1		12,13
19	27	822217	GASKET (LOWER)	1		12,13
20		821354	FACE PLATE	1		13
21	47	85089	IMPELLER	1		13
22	46	821307A	WATER PUMP BASE ASSEMBL	1		
23	26	821309	SEAL-OIL	1		12
24	26	821310	SEAL-OIL	1		12
25	25	821308	O RING	1		12
26	45	826194A	DRIVESHAFT	1	(30-3/4)(LONG)	
26	45	826195A	DRIVESHAFT	1	(33-1/3)(LL)	
27	30	821311	BALL BEARING	1		
28		823548	CABLE TIE	1		12
29		822158	BOOT-SHIFT SHAFT	1		12
30		821827	RETAINER-SHIFT SHAFT	1		
31	25	26855	O RING	1		12
32	25	85594	O RING	1		12
33	12	814803	WASHER	1		
34		82786A	SHIFT SHAFT	1	(21-1/4)(LONG)	