

Parts List

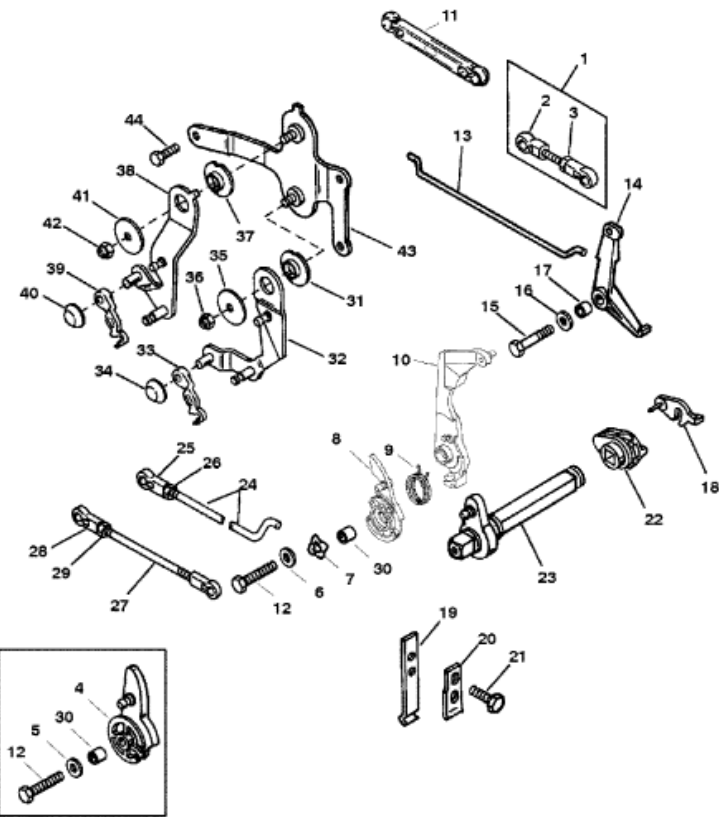

21843

Ref	Class	Part	Description	Qty	Comment	Footnote
1		823857A	LINK-SPARK ADJUSTMENT	1	SN# USA-0G437999/BEL-992699	
2		817428	SOCKET	2	SN# USA-0G437999/BEL-992699	
3	11	45076	NUT, (#10-32)	1	SN# USA-0G437999/BEL-992699	
4		823757	THROTTLE CAM	1	SN# USA-0G437999/BEL-992699	
5	12	69056	WASHER, (.255 x .620 x .03)	1	SN# USA-0G437999/BEL-992699	
6	12	65567	WASHER, (.265 x .750 x .048)	1	SN# USA-0G438000/BEL-992700	
7	13	99611	WAVE WASHER	1	SN# USA-0G438000/BEL-992700	
8		831978	THROTTLE CAM	1	SN# USA-0G438000/BEL-992700	
9	24	42164	SPRING	1	SN# USA-0G438000/BEL-992700	
10		831977	SPARK ARM	1	SN# USA-0G438000/BEL-992700	
11		832747	TIMING LINK	1	SN# USA-0G438000/BEL-992700	
12	10	40003	SCREW, (M6 x 25)	1		
13		42161	LINK INTERLOCK	1		
14		823610	LEVER, Interlock Control	1		
15	10	40003	SCREW, (M6 x 25)	1		
16	12	69056	WASHER, (.255 x .620 x .03)	1		
17	23	823806	BUSHING	1		
18		823862	LEVER, Backplate	1		
19	24	826077	SPRING, Detent	1		
20		824994	SPRING, Plate	1		
21	10	40011107	SCREW, (M5 x 16)	2		
22		823863	LEVER, Horizontal Shift Shaft (POF)	1		
23		823601	SHIFT SHAFT (HORIZONTAL)	1		
24		825211A	SHIFT ROD ASSEMBLY	1		
25		817428	SOCKET	1		
26	11	45076	NUT, (#10-32)	1		
27		823893A	THROTTLE LINK ASSEMBLY	1		
28		817428	SOCKET	2		
29	11	45076	NUT, (#10-32)	1		
30	23	823806	BUSHING	1		
31	23	825319	NYLINER	1		
32		825168	SHIFT LEVER	1		
33		822459	RETAINER	1		
34	11	825677	PUSH NUT	1		
35	12	35280	WASHER, (.255 x .620 x .030)	1		
36	11	826833	NUT, (M6)	1		
37	23	825319	NYLINER	1		
38		825169	THROTTLE LEVER	1		
39		822459	RETAINER	1		
40	11	825677	PUSH NUT	1		
41	12	35280	WASHER, (.255 x .620 x .030)	1		