

V8-300-A

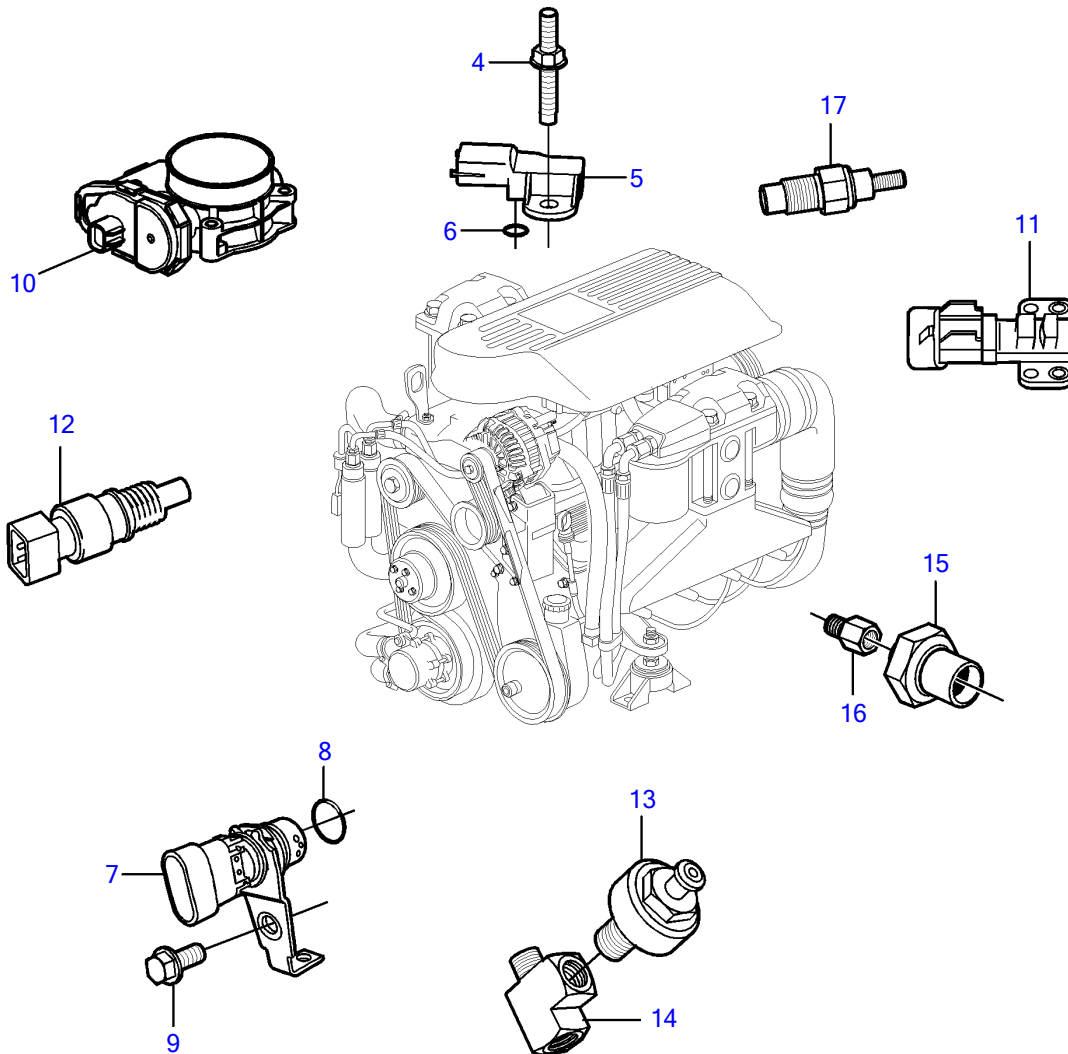
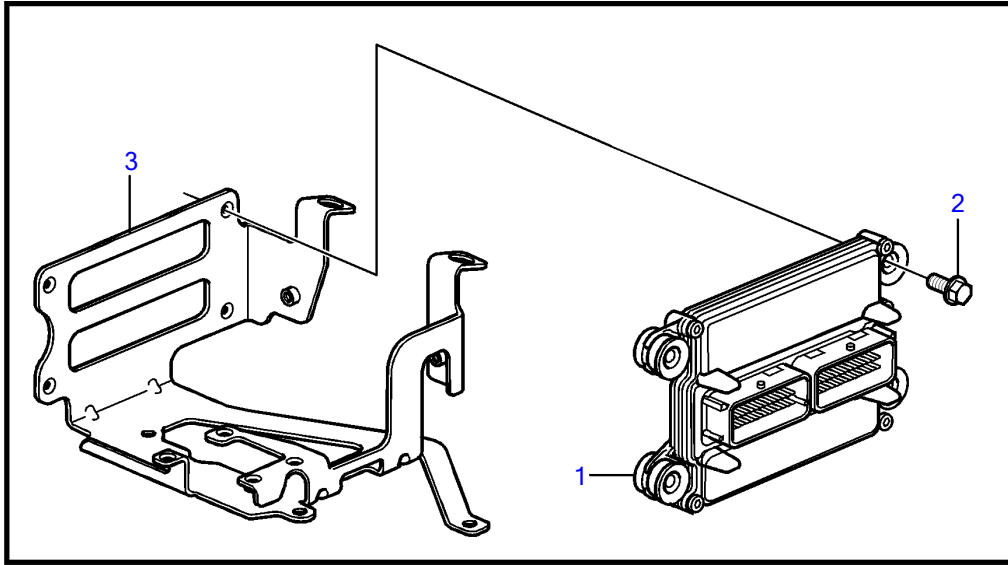

V8-300-A

REF	PART NO.	QTY	DESCRIPTION	NOTES
1	21881858	1	Module	
2	3843651	4	Flange screw	
3	21333459	1	Bracket	
4	3858973	1	Bolt	
5	3859020	1	Sensor, MAT/MAP	
6	3858988	1	• Sealing	
7	3858979	1	Sensor, crankshaft position	
8	3859009	1	• O-ring	
9	3858983	1	Bolt	
10		1	Throttle body	See "Throttle Body" page
		2	• Sensor, throttle position	
		1	• Switch, idle validation	
11	3863130	1	Sensor, camshaft position	
12	3850397	1	Switch, temperature	
13	3850357	2	Knock sensor	replaced by next part number
	22024631	2	Knock sensor	
14	3849477	1	Adapter	Starboard
	3593571	1	Fitting	Port
15	3887328	1	Sensor	
16	3887970	1	Fitting	
17	3862500	2	Temperature sensor	