

V8-270-E-A

D=52mm

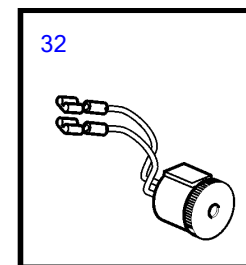
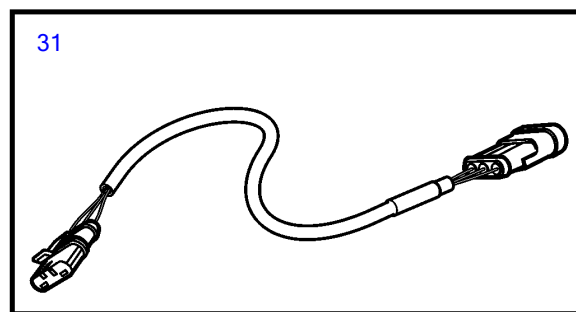
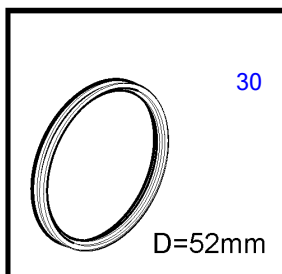
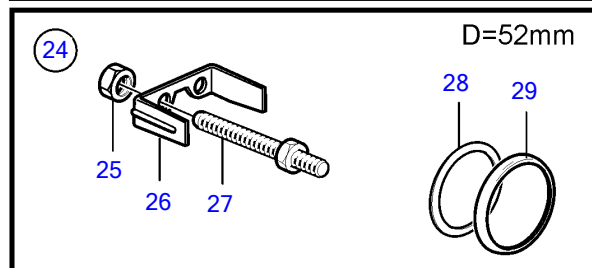
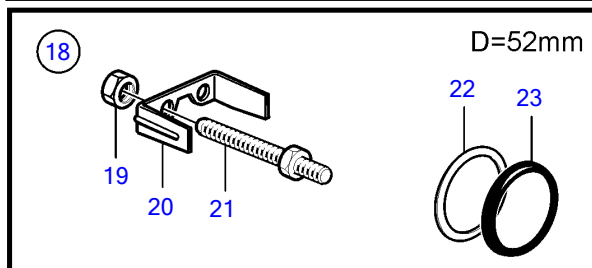
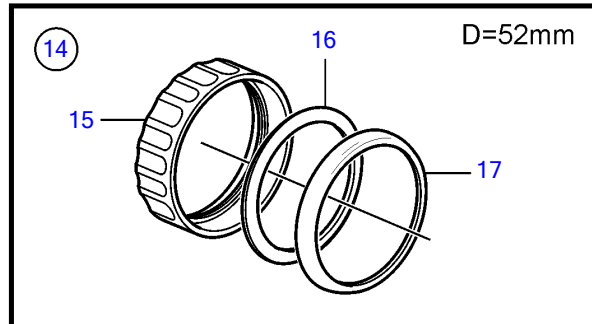
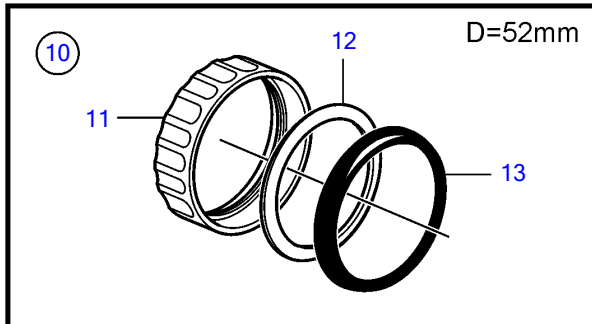
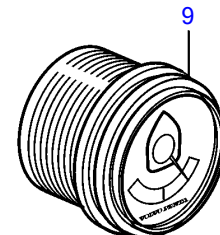
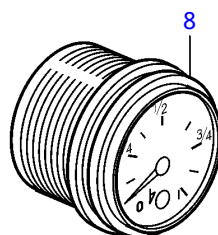
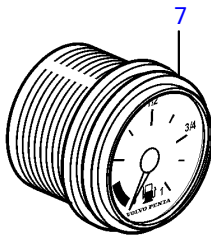
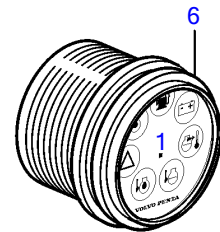
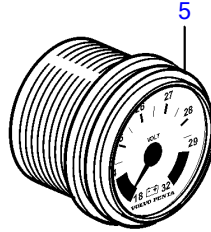
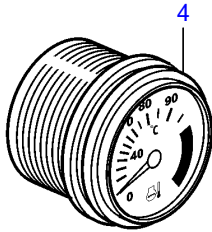
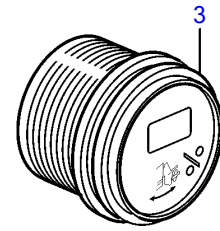
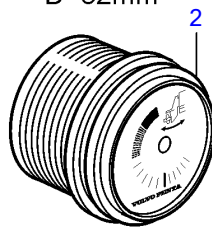
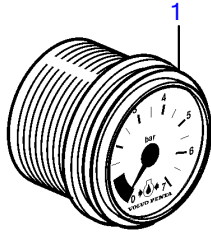

## V8-270-E-A

REF	PART NO.	QTY	DESCRIPTION	NOTES
1	874919	1	Oil pressure gauge	Black 0-100 psi
	874932	1	Oil pressure gauge	White, 0-100 psi
	874908	1	Oil pressure gauge	Black, 0-7 bar
	874923	1	Oil pressure gauge	White, 0-7 bar
2	3812881	1	Instrument	Black, Analog
	3812911	1	Instrument	White, Analog
3	881648	1	Trimmer	Black, Digital
	881654	1	Trimmer	White, Digital
4	874904	1	Thermometer, coolant water	Black, 0-120°C
	874921	1	Thermometer, coolant water	White, 0-120°C
	874918	1	Thermometer, coolant water	Black, 40-250° f
	874931	1	Thermometer, coolant water	White, 40-250° f
5	881649	1	Voltmeter	12V, Black
	881658	1	Voltmeter	12V, White
6	874915	1	Instrument, alarm	Black
	874927	1	Instrument, alarm	White
7	874914	1	Fuel gauge	Black
	874926	1	Fuel gauge	White
8	3809992	1	Water level gauge, water tank	Black
	3809993	1	Water level gauge, water tank	White
9	3812914	1	Rudder indicator	Black
	3812917	1	Rudder indicator	White
10	874709	1	Mounting kit	Black
11	874450	1	• Attaching ring	
12	874707	1	• Gasket	
13	874448	1	• Ring	
14	874733	1	Mounting kit	Chrome
15	874450	1	• Attaching ring	
16	874707	1	• Gasket	
17	874731	1	• Ring	
18	881611	1	Brace kit	Black
19	881610	2	• Nut	
20	881607	1	• Brace	
21	881609	2	• Stud	
22	874707	1	• Gasket	
23	874448	1	• Ring	
24	881613	1	Brace kit	Chrome
25	881610	2	• Nut	
26	881607	1	• Brace	
27	881609	2	• Stud	
28	874707	1	• Gasket	
29	874731	1	• Ring	
30	874843	1	X-ring	For flush mounting.
31	874759	1	Extension cable'verl	L=1000mm
	3807043	1	Extension cable'verl	L=3000mm
32	3817974	1	Alarm	