

5.7GiI-E, 5.7GXil-F

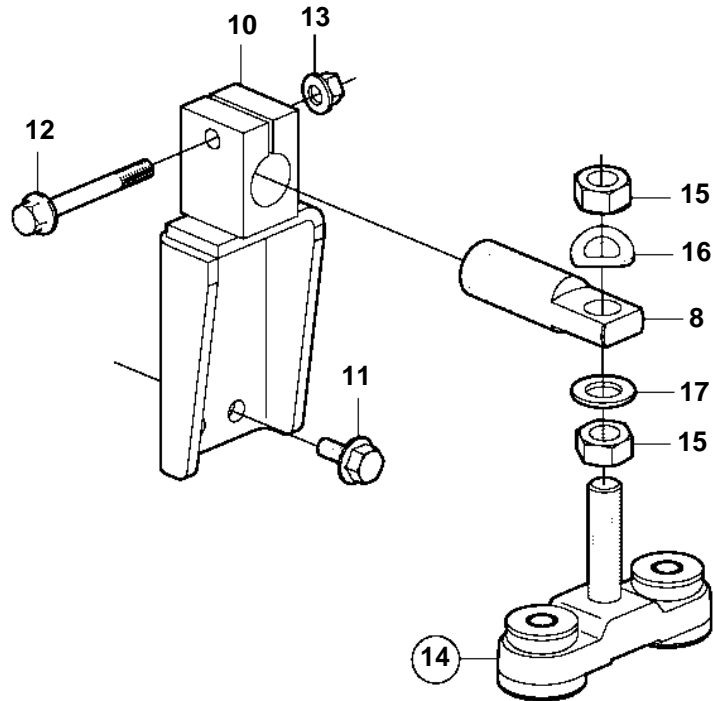
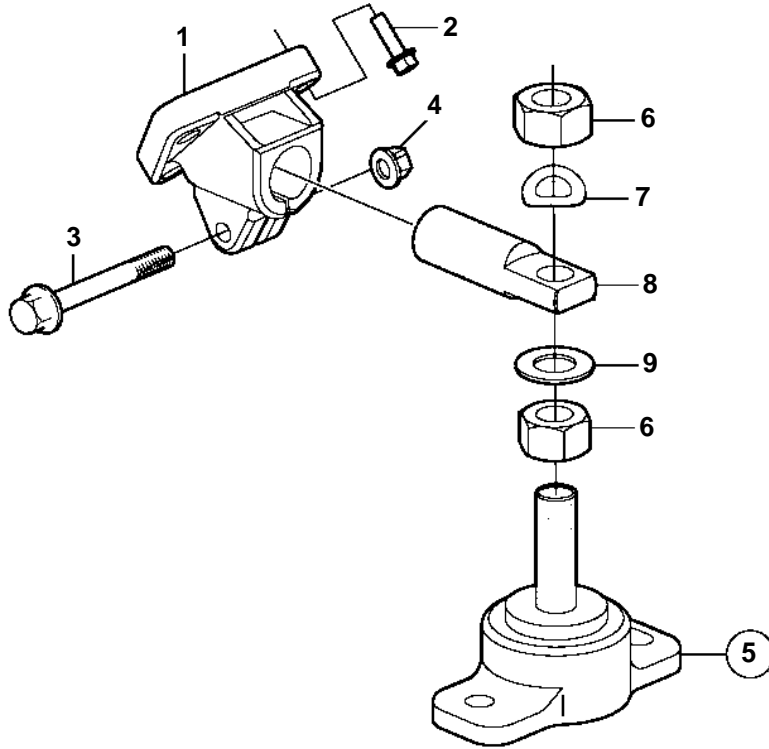

5.7GiI-E, 5.7GXii-F

REF	PART NO.	QTY	DESCRIPTION
1	3863314	2	Bracket
2	3860582	6	Screw
3	3860499	2	Screw
4	3857181	2	Flange lock nut
5	857251	2	Rubber cushion
6	955860	4	• Hexagon nut
7	941914	2	Spring washer
8	3863365	4	Pin
9	3857588	2	Washer
10	3858472	2	Engine mountings
11	965191	8	Flange screw
12	3855595	2	Screw
13	946175	2	Flange nut
14	3858470	2	Engine pad
15	955860	4	• Hexagon nut
16	941914	2	• Spring washer
17	955902	2	• Washer