

5.0GXIE-270-R

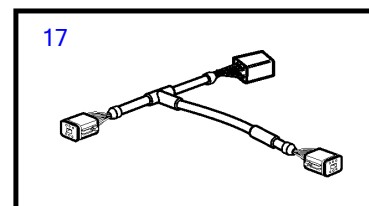
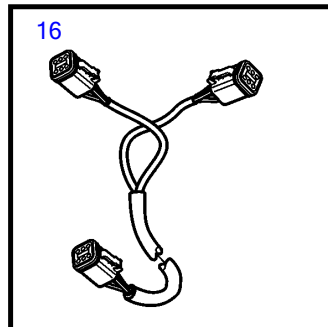
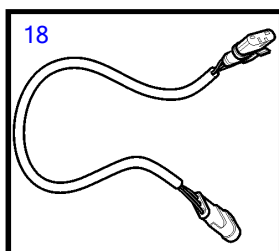
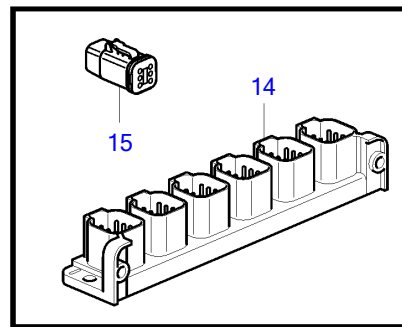
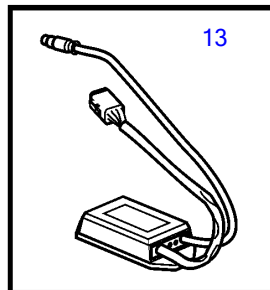
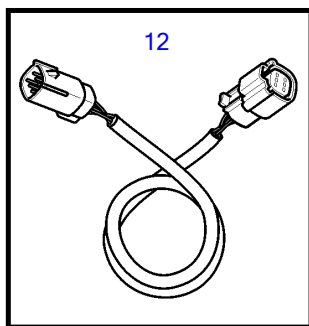
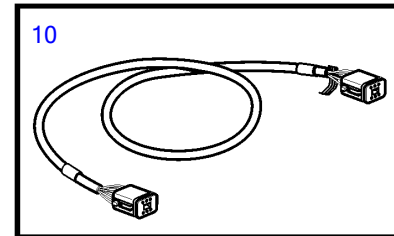
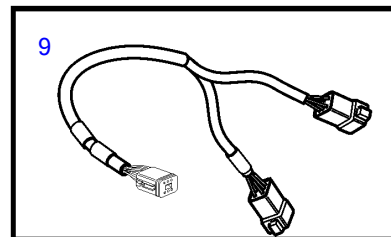
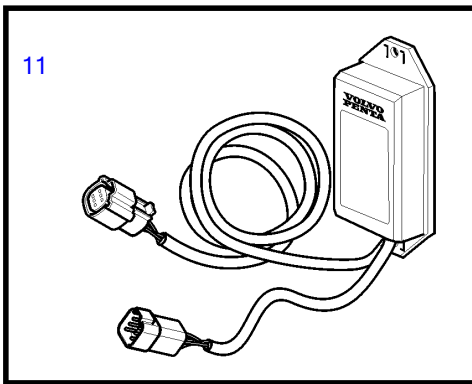
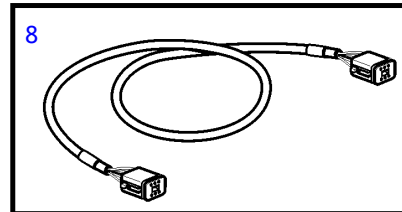
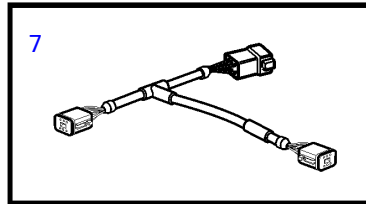
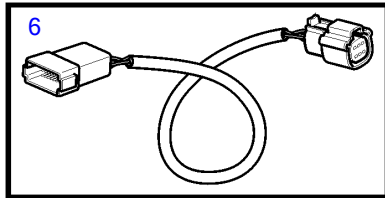
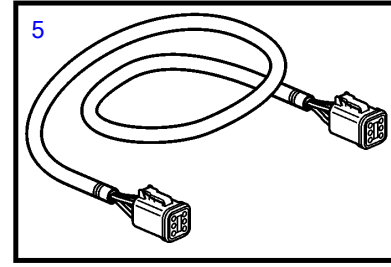
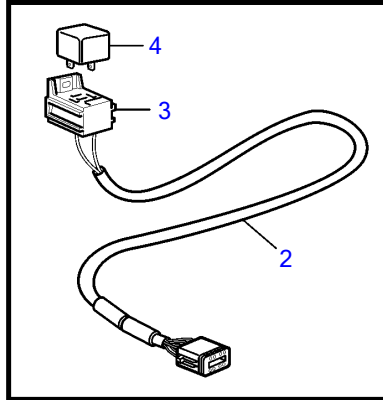
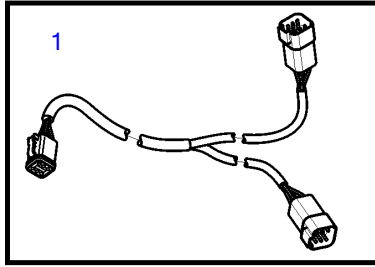

5.0GXIE-270-R

| REF | PART NO. | QTY | DESCRIPTION | SEE SEC. | NOTES |
|-----|----------|-----|---------------------------|-------------|---|
| 1 | 21825662 | 1 | Cable | | Y-split, multisensor |
| 2 | 21427463 | 1 | Cable | | Auxiliary relay |
| 3 | 977184 | 1 | • Housing | | |
| 4 | 873765 | 1 | Relay | | 12V |
| 5 | 3889410 | 1 | Extension cable'verl | | L=1.5m |
| | 3842733 | 1 | Extension cable'verl | | L=3.0m |
| | 3842734 | 1 | Extension cable'verl | | L=5.0m |
| | 3842735 | 1 | Extension cable'verl | | L=7.0m |
| | 3842736 | 1 | Extension cable'verl | | L=9.0m |
| | 3842737 | 1 | Extension cable'verl | | L=11.0m |
| | 21172469 | 1 | Extension cable'verl | | L=20m |
| | 21172470 | 1 | Extension cable'verl | | L=40m |
| 6 | 21421945 | 1 | Cable | | Steering adapter |
| 7 | 3588972 | 1 | Cable kit | | Y-connector bus cable, 6-pole., L=0.5m |
| | 874960 | 2 | • Housing | | |
| | 874959 | 1 | • Housing | | |
| 8 | 3886666 | 1 | Cable, multilink | | L=1.5m |
| | 21166002 | 1 | Wiring harness, multilink | | 7m |
| | 21166003 | 1 | Wiring harness, multilink | | 9m |
| | 21166004 | 1 | Wiring harness, multilink | | 13m |
| 9 | 3588206 | 1 | Cable kit, y-split | | |
| 10 | 21865234 | 1 | Cable | | L=1.5m |
| | 874789 | 1 | Cable kit | | L=5.0m |
| | 889550 | 1 | Cable | | L=7.0m |
| | 889551 | 1 | Cable | | L=9.0m |
| | 889552 | 1 | Cable | | L=11.0m |
| | 888013 | 1 | Cable | | L=13.0m |
| 11 | 21460908 | 1 | Converter | | A-can converter |
| 12 | 21480272 | 1 | Cable | | Extension cable, 6 pin. 1.5m, steering |
| 13 | 3848966 | 1 | Control unit | | Dimmer unit |
| | | | • Bulletin P-38-1-1 | P-38-1-1-EN | ADU - Automatic Dimmer Unit |
| 14 | 21469055 | 1 | Connection block | | Multi-link hub |
| 15 | 21825714 | 1 | Terminal | | |
| 16 | 21287072 | | Wiring harness | | T-cable, Multi-link hub |
| | 874960 | 3 | • Housing | | |
| 17 | 21427460 | 1 | Cable | | T-cable, Datalink |
| 18 | 874759 | 1 | Extension cable'verl | | extension cable, Easy-link gauges, L=1.0m |
| | 3807043 | 1 | Extension cable'verl | | extension cable, Easy-link gauges, L=3.0m |