

5.0GXICE-270-R, 5.0GiCE-225-S

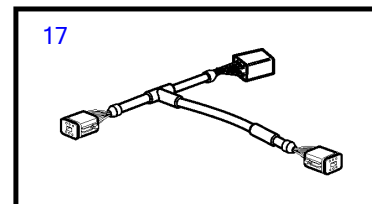
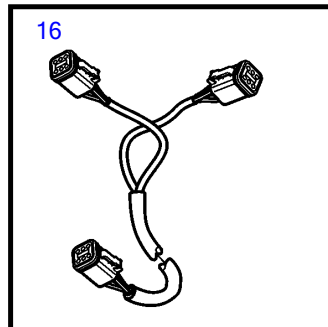
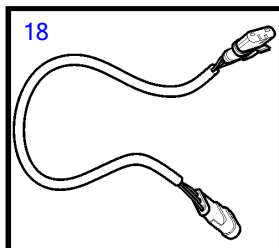
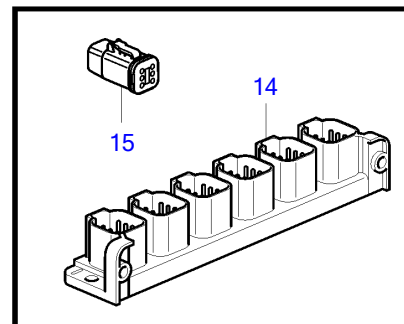
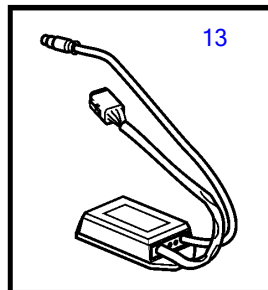
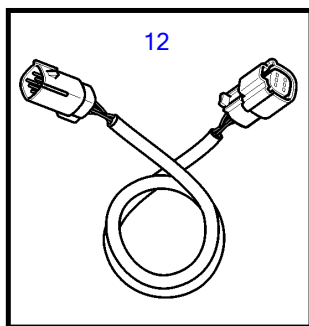
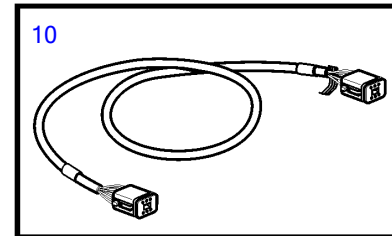
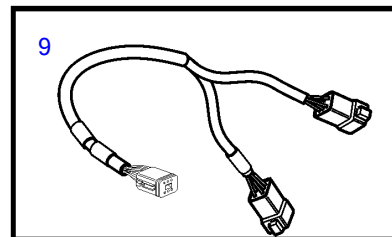
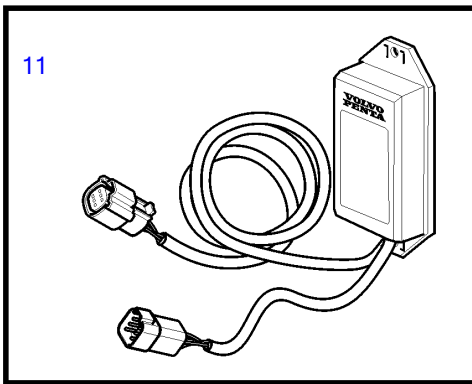
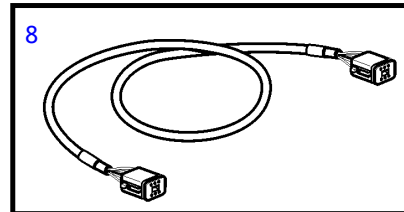
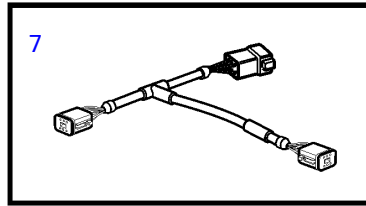
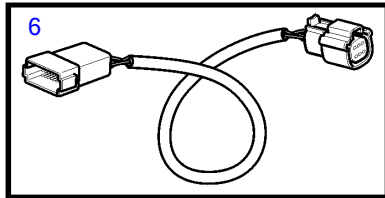
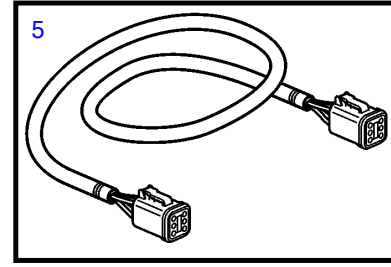
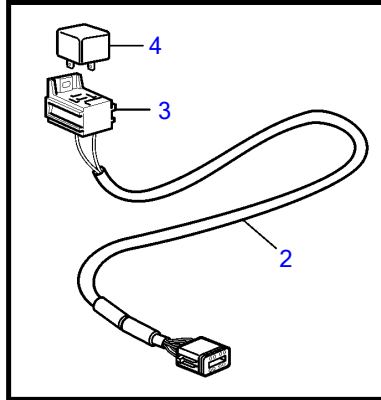
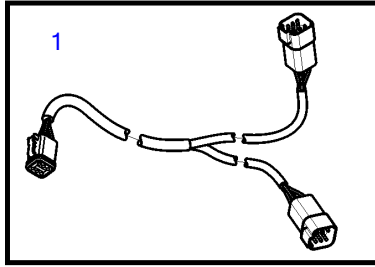

5.0GXICE-270-R, 5.0GiCE-225-S

REF	PART NO.	QTY	DESCRIPTION	SEE SEC.	NOTES
1	21825662	1	Cable		Y-split, multisensor
2	21427463	1	Cable		Auxiliary relay
3	977184	1	• Housing		
4	873765	1	Relay		12V
5	3889410	1	Extension cable'verl		L=1.5m
	3842733	1	Extension cable'verl		L=3.0m
	3842734	1	Extension cable'verl		L=5.0m
	3842735	1	Extension cable'verl		L=7.0m
	3842736	1	Extension cable'verl		L=9.0m
	3842737	1	Extension cable'verl		L=11.0m
	21172469	1	Extension cable'verl		L=20m
	21172470	1	Extension cable'verl		L=40m
6	21421945	1	Cable		Steering adapter
7	3588972	1	Cable kit		Y-connector bus cable, 6-pole., L=0.5m
	874960	2	• Housing		
	874959	1	• Housing		
8	3886666	1	Cable, multilink		L=1.5m
	21166002	1	Wiring harness, multilink		7m
	21166003	1	Wiring harness, multilink		9m
	21166004	1	Wiring harness, multilink		13m
9	3588206	1	Cable kit, y-split		
10	21865234	1	Cable		L=1.5m
	874789	1	Cable kit		L=5.0m
	889550	1	Cable		L=7.0m
	889551	1	Cable		L=9.0m
	889552	1	Cable		L=11.0m
	888013	1	Cable		L=13.0m
11	21460908	1	Converter		A-can converter
12	21480272	1	Cable		Extension cable, 6 pin. 1.5m, steering
13	3848966	1	Control unit		Dimmer unit
			• Bulletin P-38-1-1	P-38-1-1-EN	ADU - Automatic Dimmer Unit
14	21469055	1	Connection block		Multi-link hub
15	21825714	1	Terminal		
16	21287072		Wiring harness		T-cable, Multi-link hub
	874960	3	• Housing		
17	21427460	1	Cable		T-cable, Datalink
18	874759	1	Extension cable'verl		extension cable, Easy-link gauges, L=1.0m
	3807043	1	Extension cable'verl		extension cable, Easy-link gauges, L=3.0m