

5.0GXi-G, 5.0GXi-GF, 5.0OSi-G, 5.0OSi-GF

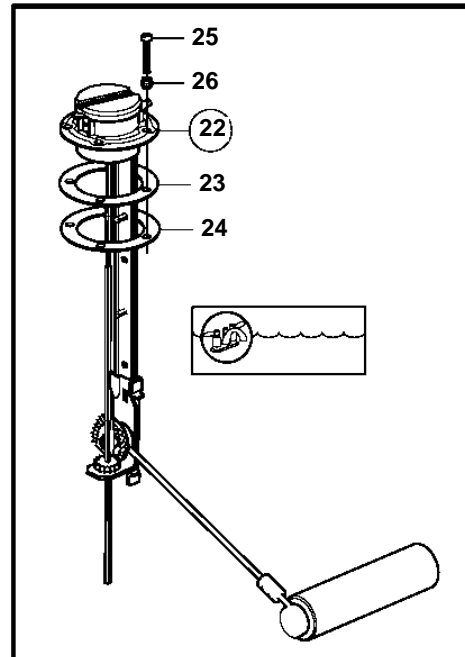
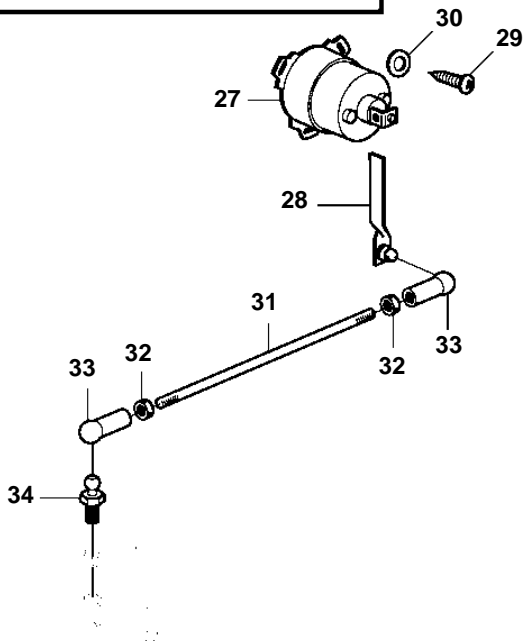
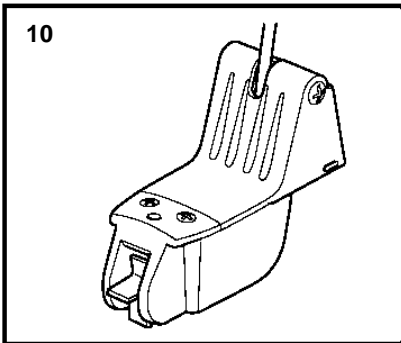
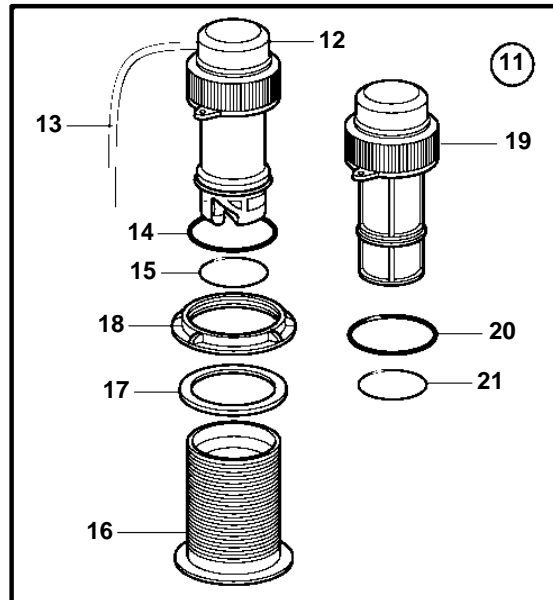
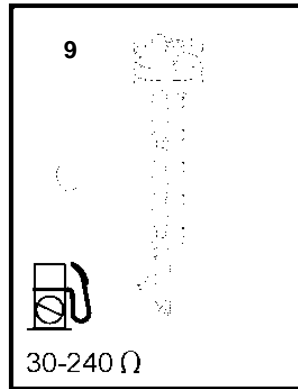
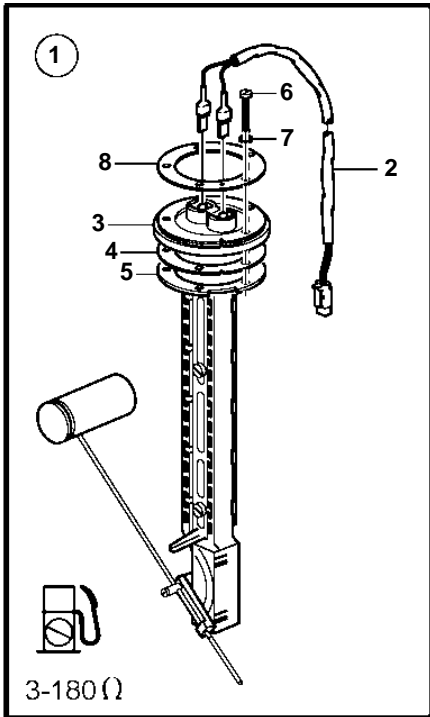

24017

## 5.0GXi-G, 5.0GXi-GF, 5.0OSi-G, 5.0OSI-GF

REF	PART NO.	QTY	DESCRIPTION	NOTES
1	3812291	1	Sensor kit, fuel level	3-180 Ohms
2	874807	1	· Cable kit	L=6.0m
3	873772	1	· Tank sensor	
4	89865	1	· · Gasket	
5	834480	1	· · Flange	
6	969408	4	· · 6 point socket screw	L=20mm
		1	· · Screw	L=30mm
7	834481	5	· · Gasket	
8		1	· · Flange	not sold separately
9		1	Sender, fuel level	30-240 Ohms, Not supplied by Volvo Penta
10	3587055	1	Kit, multi-sensor	Mounted on transom
11	3587054	1	Kit, multi-sensor	Through hull
12		1	· Sender	not sold separately
13		1	· Cable	not sold separately
14		1	· O-ring	not sold separately
15		1	· O-ring	not sold separately
16		1	· Fitting, through hull	not sold separately
17		1	· Seal	not sold separately
18		1	· Nut	not sold separately
19		1	· Plug	not sold separately
20		1	· O-ring	not sold separately
21		1	· O-ring	not sold separately
22	834389	1	Sensor, water level	
23	89865	1	· Gasket	
24	834480	1	· Flange	
25	969407	4	· 6 point socket screw	L=16mm
		1	· Screw	L=30mm
26	834481	5	· Gasket	
27	837772	1	Position sensor, drive	
28	3863388	1	Arm	
29	955132	3	Cross recessed screw	
30	955891	3	Washer	
31	943549	1	Control rod	
32	942836	1	Hexagon nut	Left hand threads.
	955780	1	Hexagon nut	Right hand threads.
33	946704	1	Ball socket	Left hand threads.
	946703	1	Ball socket	Right hand threads.
34	21319346	1	Ball stud	