

230A, 230B, 250A, 250B

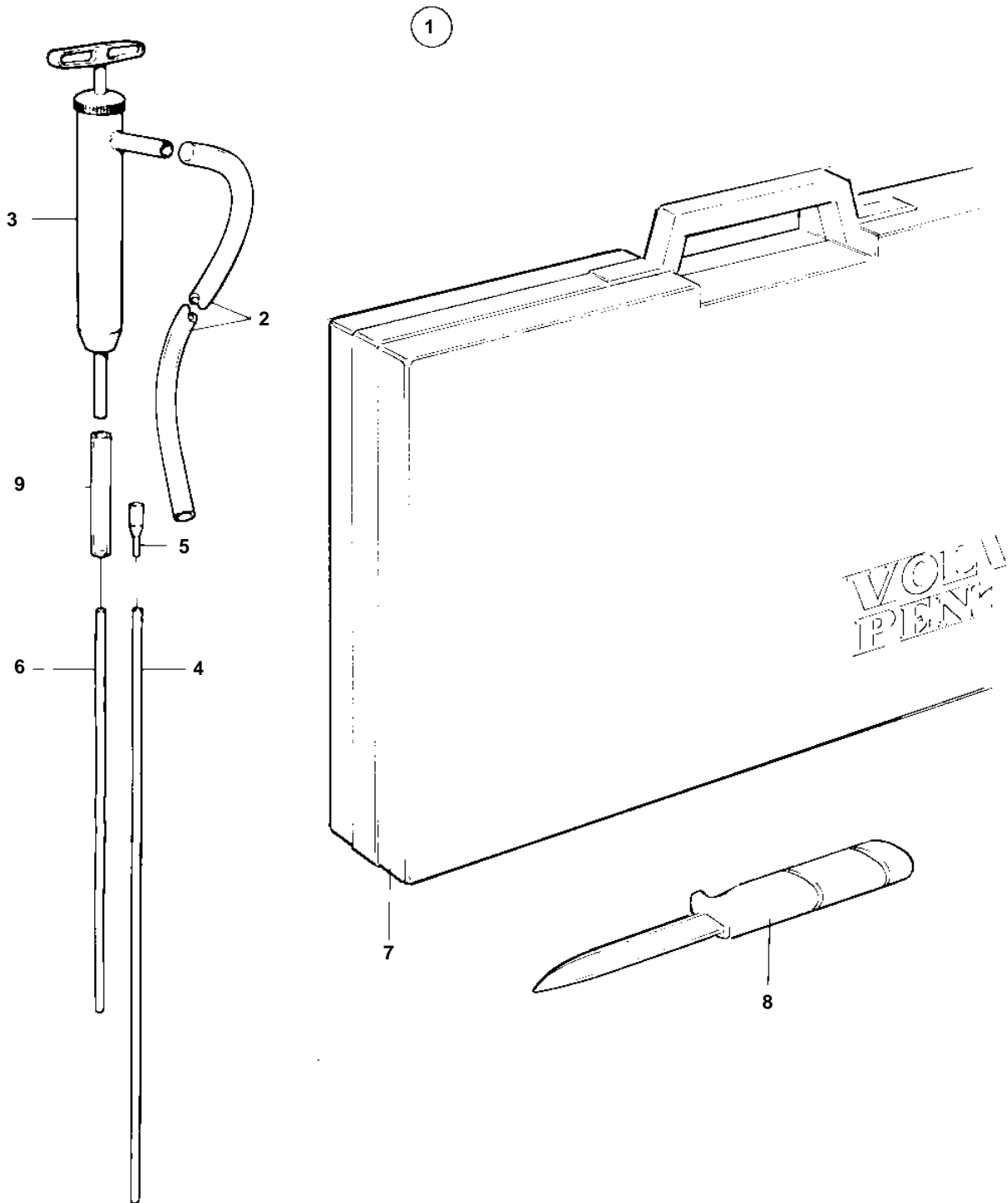

8804

