

TMD41D, TAMD41D

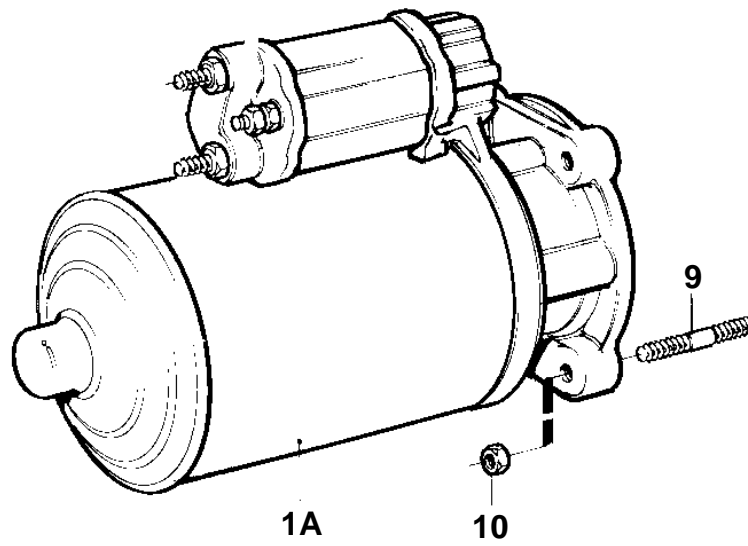
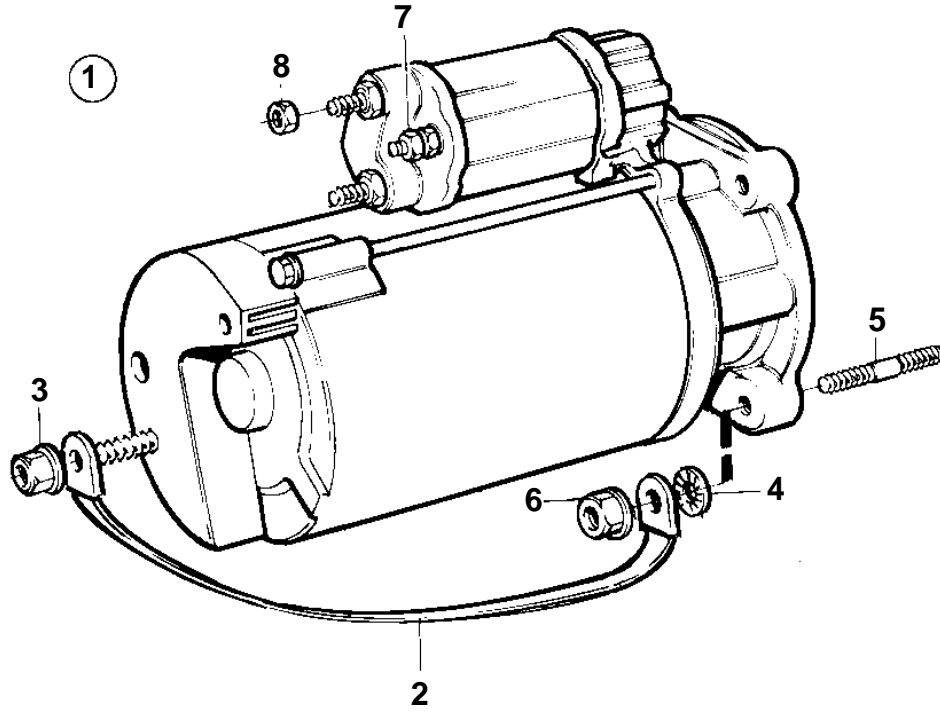

11119

TMD41D, TAMD41D

REF	PART NO.	QTY	DESCRIPTION	SEE SEC.	NOTES
1	859252	1	Starter motor		12V
				583	
1A	838987	1	Starter motor		24V
				968	
2	968048	1	Ground cable		
3	968862	1	Nut		
4	945987	1	Lock washer		
5	953067	2	Stud		L=45mm
	953069	1	Stud		L=50mm
6	971095	3	Nut		
7	965483	1	Nut		
8	968862	1	Nut		
9	953067	2	Stud		L=45mm
	953069	1	Stud		L=50mm
10	971095	3	Nut		