

COMMON

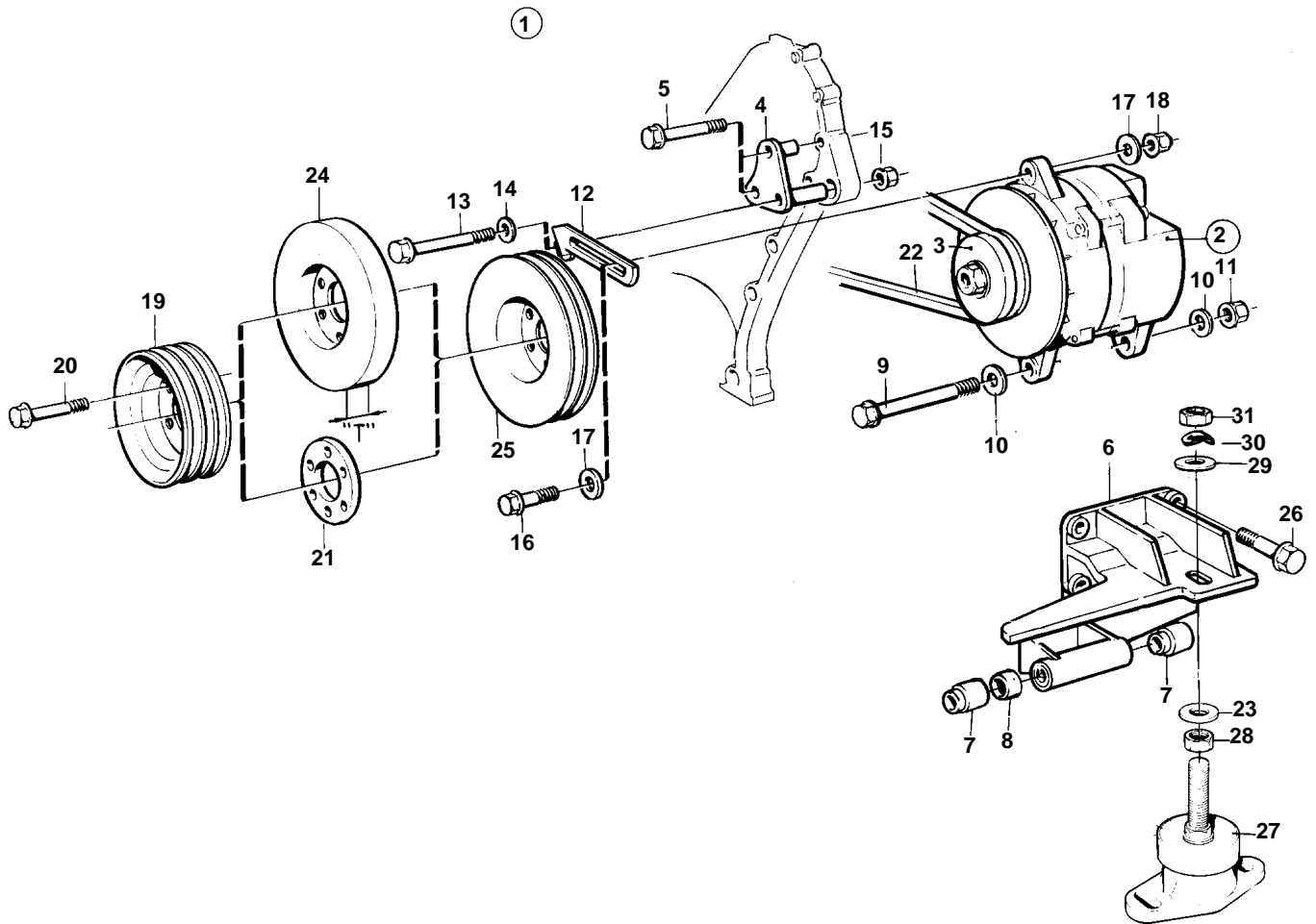

11123

COMMON

REF	PART NO.	QTY	DESCRIPTION	SEE SEC.	NOTES
1	861156	1	Alternator kit		Fits engines with damper thickness TH= 35mm and TH= 41mm.
2	849747	1	• Alternator		14V, 130A
	3803577	1	• Alternator,exch		Exchange unit
				594	
3	858191	1	• Pulley		
4	860869	1	• Bracket		
5	965181	2	• Screw		
6	860868	1	• Bracket		
7	859574	2	• • Bushing		
8		1	• • Sleeve		
9	970988	1	• Screw		
10	955897	2	• Washer		
11	971099	1	• Flange lock nut		
12	859075	1	• Tensioner		
13	970963	1	• Screw		
14	960148	1	• Washer		
15	971098	1	• Flange lock nut		
16	946752	1	• Flange screw		
17	960143	2	• Washer		
18	971098	1	• Flange lock nut		
19	861123	1	• Pulley		Fits engines with damper thickness TH= 35mm and TH= 41mm.
20	973080	6	• Screw		
21	860870	1	• Spacer		
22	966391	1	• V-belt kit		
23	945544	1	• Washer		Only used for rubber element with M16 bolt.
24		1	Absorber		ALT. SEE GROUP 21
25		1	Pulley		SEE GROUP 21
26		4	Screw		SEE GROUP 21
27		X	Rubber element		SEE GROUP 21
28		X	Nut		SEE GROUP 21
29		X	Washer		SEE GROUP 21
30		X	Spring washer		SEE GROUP 21
31		X	Nut		SEE GROUP 21