

COMMON

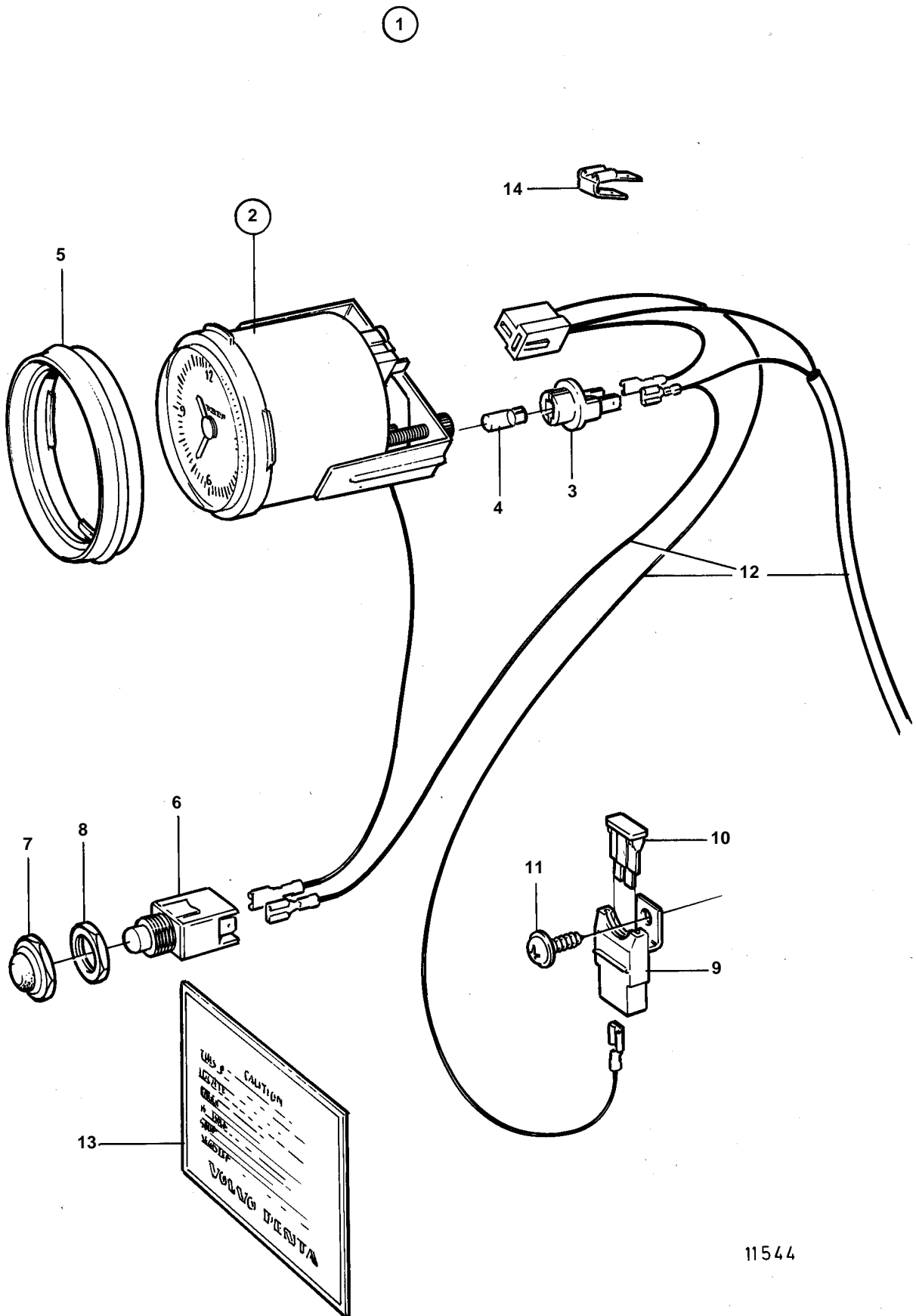

11544

COMMON

REF	PART NO.	QTY	DESCRIPTION	NOTES
1	1140597	1	Clock kit	
2	856814	1	· Clock	
3	863945	1	· · Bulb socket	
4	863946	1	· · Bulb	
5	858643	1	· Front ring	
6	828584	1	· Switch	
7	828586	1	· Nut	
8	872407	1	· Nut	
9	1323312	1	· Fuse holder	
10	969115	1	· Fuse	3A
11	965391	1	· Screw	(965391)
12	872492	1	· Cable kit	
13	841242	1	· Decal	
14	943950	1	· Cable terminal	