

AD31D, AD31XD

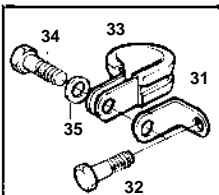
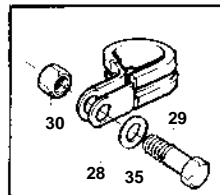
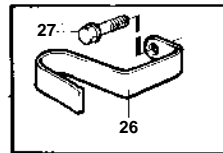
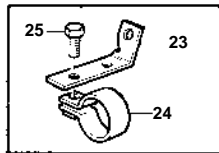
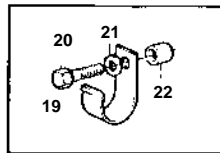
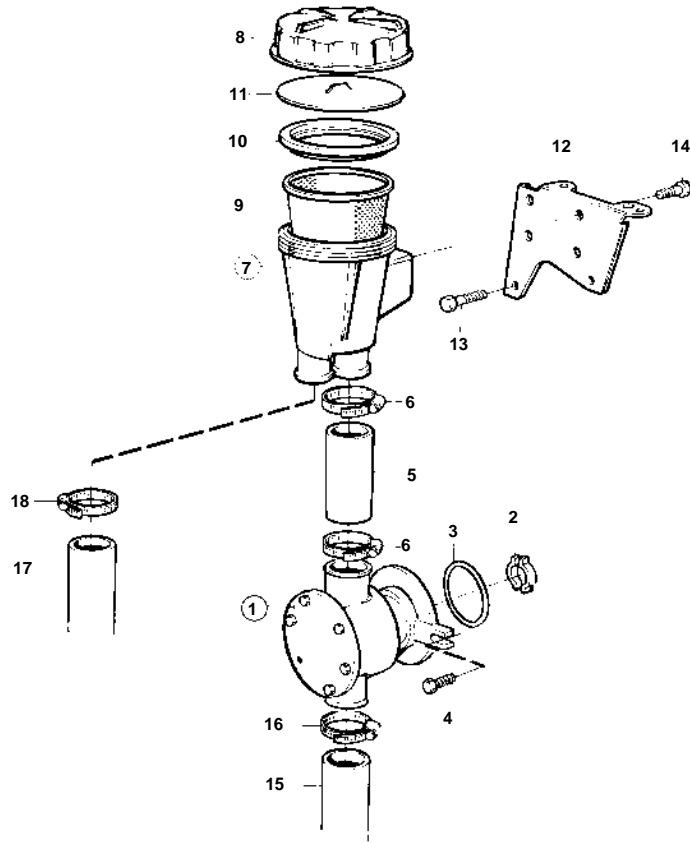

11481

AD31D, AD31XD

REF	PART NO.	QTY	DESCRIPTION	SEE SEC.	NOTES
1	860629	1	Sea water pump	556	
2	858467	1	Companion flange		
3	968971	1	O-ring		
4	946173	2	Flange screw		
5	949315	1	Hose		L=60mm
6	943476	2	Hose clamp		
7	860631	1	Sea water filter		
8	842722	1	· Cover		
9	860687	1	· Strainer		
10	842724	1	· Seal		
11	842982	1	· Pressure plate		
12	860611	1	Bracket		
13	946470	1	Flange screw		L=35mm
	948217	1	Flange screw		L=45mm
14	944926	4	Flange screw		
15	860688	1	Hose		Intake-sea water pump.
16	961669	2	Hose clamp		
17	861018	1	Hose		Sea water filter-oil cooler.
18	943476	1	Hose clamp		
19	857045	1	Clamp		
20	945444	1	Flange screw		
21	955894	1	Washer		
22	843075	1	Sleeve		
23	860701	1	Bracket		
24	860700	1	Clamp		
25	946671	1	Flange screw		
26	861387	1	Bracket		
27	947760	1	Flange screw		
28	952640	1	Clamp		ALT, P.S
29	946544	1	Flange screw		ALT, P.S
30	949278	1	Lock nut		ALT, P.S
31	846780	1	Bracket		ALT
32	965181	1	Screw		ALT
33	952640	1	Clamp		ALT
34	968855	1	Flange screw		ALT
35	955893	1	Washer		