

TMD122A, TAMD122A

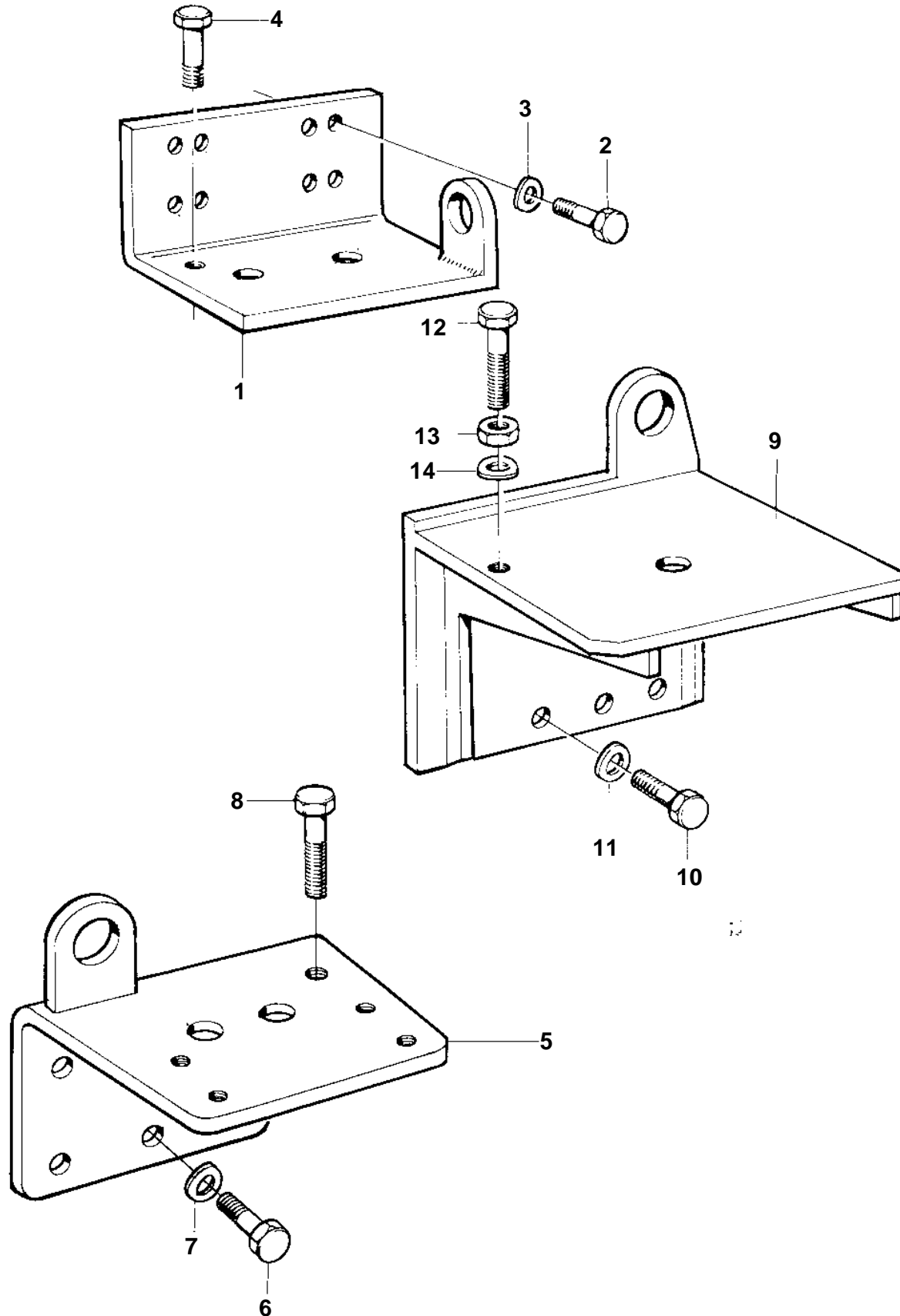

16078

TMD122A, TAMD122A

REF	PART NO.	QTY	DESCRIPTION		NOTES
5	865485	1	Bracket	SO	S.B
	865486	1	Bracket	SO	P
6	955590	12	Screw		
7	941912	12	Spring washer		
8	970972	2	Screw		