

COMMON

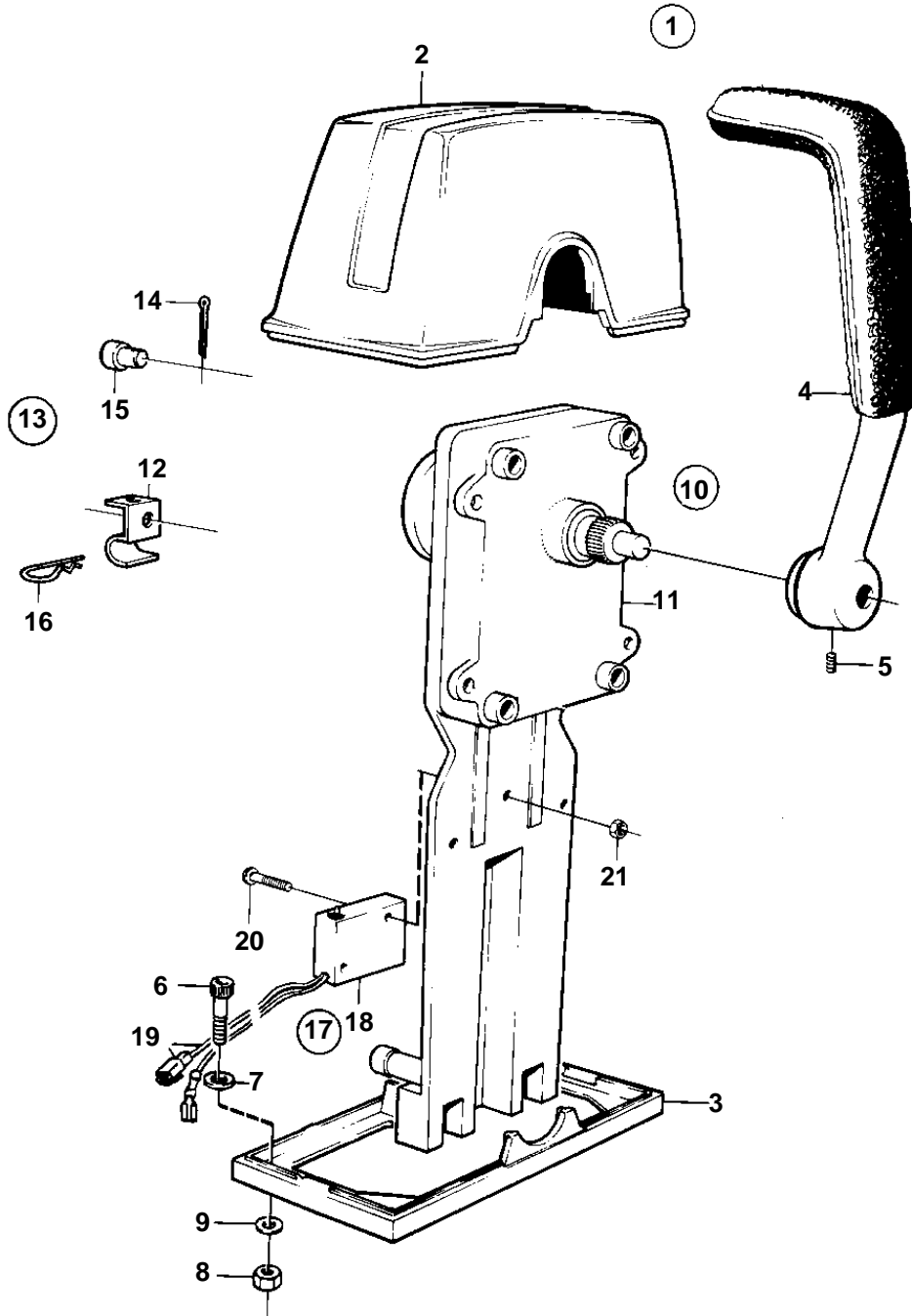

9266

COMMON

REF	PART NO.	QTY	DESCRIPTION	NOTES
1	851602	1	Mounting kit	For single installation.
2	850823	1	· Cover	(839472)
3	839474	1	· Plate	
4	839475	1	· Lever	
5	839693	1	· Lock screw	
6	947671	4	· Allen head screw	
7	940090	2	· Washer	
8	955780	4	· Nut	
9	960138	4	· Washer	
10	851600	1	Control	
11		1	· Control mechanism	
12	853423	1	· Retainer	
13		1	· Connector kit	
14	17253	2	· · Cotter pin	
15	839638	2	· · Cube	
16	852924	1	· · Clip	
17	855352	1	Neutral posit contac	
18	850200	1	· Switch	
19		X	· · Cables and terminals	SE GROUP 30
20	946177	2	· Screw	
21	947536	2	· Nut	