

COMMON

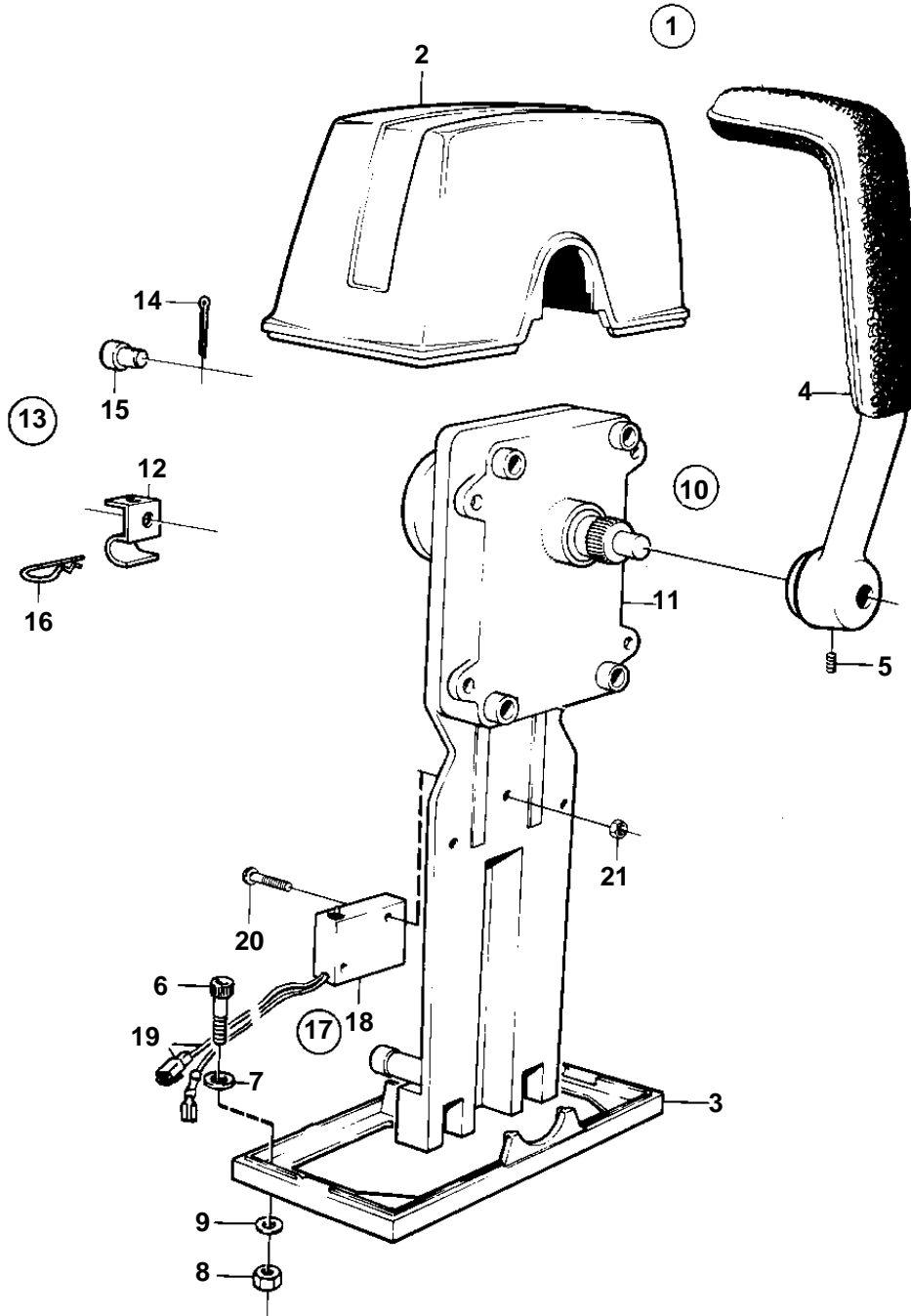

9266

COMMON

REF	PART NO.	QTY	DESCRIPTION	NOTES
1	851603	1	Mounting kit	For twin installation.
2	850824	1	· Cover	(839477)
3	839479	1	· Plate	
4	839475	2	· Lever	
5	839693	2	· Lock screw	
6	947671	6	· Allen head screw	
7	940090	2	· Washer	
8	955780	6	· Nut	
9	960138	6	· Washer	
10	851600	2	Control	
11		2	· Control mechanism	
12	853423	2	· Retainer	
13		2	· Connector kit	
14	17253	4	· · Cotter pin	
15	839638	4	· · Cube	
16	852924	2	· · Clip	
17	855352	2	Neutral posit contac	
18	850200	2	· Switch	
19		X	· · Cables and terminals	SE GROUP 30
20	946177	4	· Screw	
21	947536	4	· Nut	