

COMMON, MD2010B, MD2010C, MD2020B, MD2020C, MD2030B, MD2030C, MD2040B, MD2040C, TAMD63L-A, TAMD63L-B, TAMD63P-A, TAMD71B, TAMD71B (AUX), TAMD73P-A, TAMD73WJ-A, TAMD74A-A, TAMD74A-B, TAMD74C-A, TAMD74L-A, TAMD74P-A, TAMD74C-B, TAMD74L-B, TAMD74P-B, D2-55A

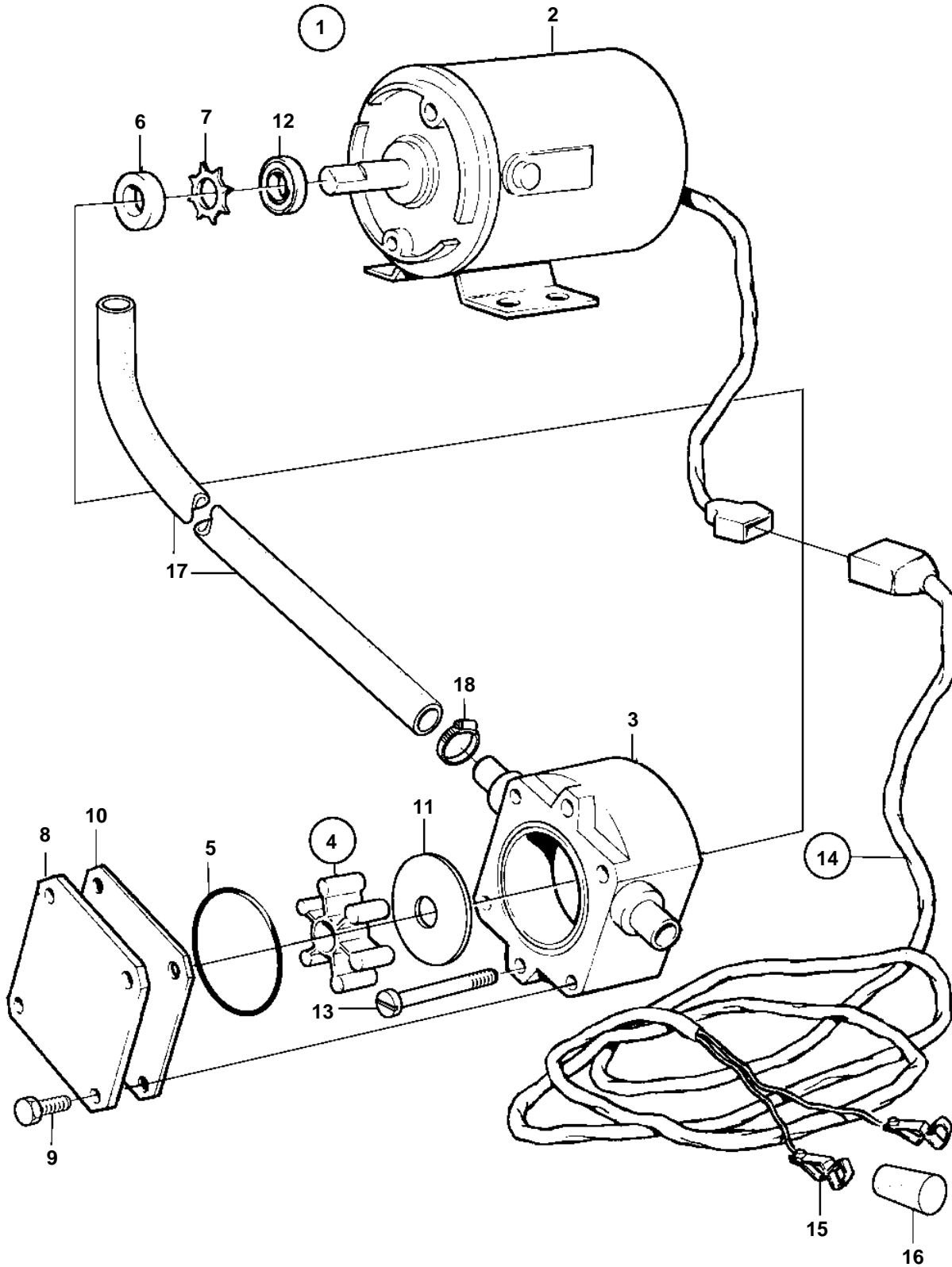

COMMON, MD2010B, MD2010C, MD2020B, MD2020C, MD2030B, MD2030C, MD2040B, MD2040C, TAMD63L-A, TAMD63L-B, TAMD63P-A, TAMD71B, TAMD71B (AUX), TAMD73P-A, TAMD73WJ-A, TAMD74A-A, TAMD74A-B, TAMD74C-A, TAMD74L-A, TAMD74P-A, TAMD74C-B, TAMD74L-B, TAMD74P-B, D2-55A

REF	PART NO.	QTY	DESCRIPTION	NOTES
1	843410	1	Oil bilge pump	24V
2	842222	1	· Electrical motor	
3	844015	1	· · Housing	
4	844022	1	· · Impeller kit	
5		1	· · · O-ring	
6		1	· · · Sealing ring	
7		1	· · · Lock ring	
8	844018	1	· · Cover	
9	844021	4	· · Screw	
10	844017	1	· · Wear washer	
11	844016	1	· · Wear washer	
12	844019	1	· · Oil deflector ring	
13	847464	2	· · Screw	
14	843113	1	· Cable trunk	
15	844280	2	· · Cable terminal	
16		1	· · Isolator	BLACK
		1	· · Isolator	RED
17	943707	X	· Rubber hose	
18	943471	3	· Hose clamp	