

TAMD61A

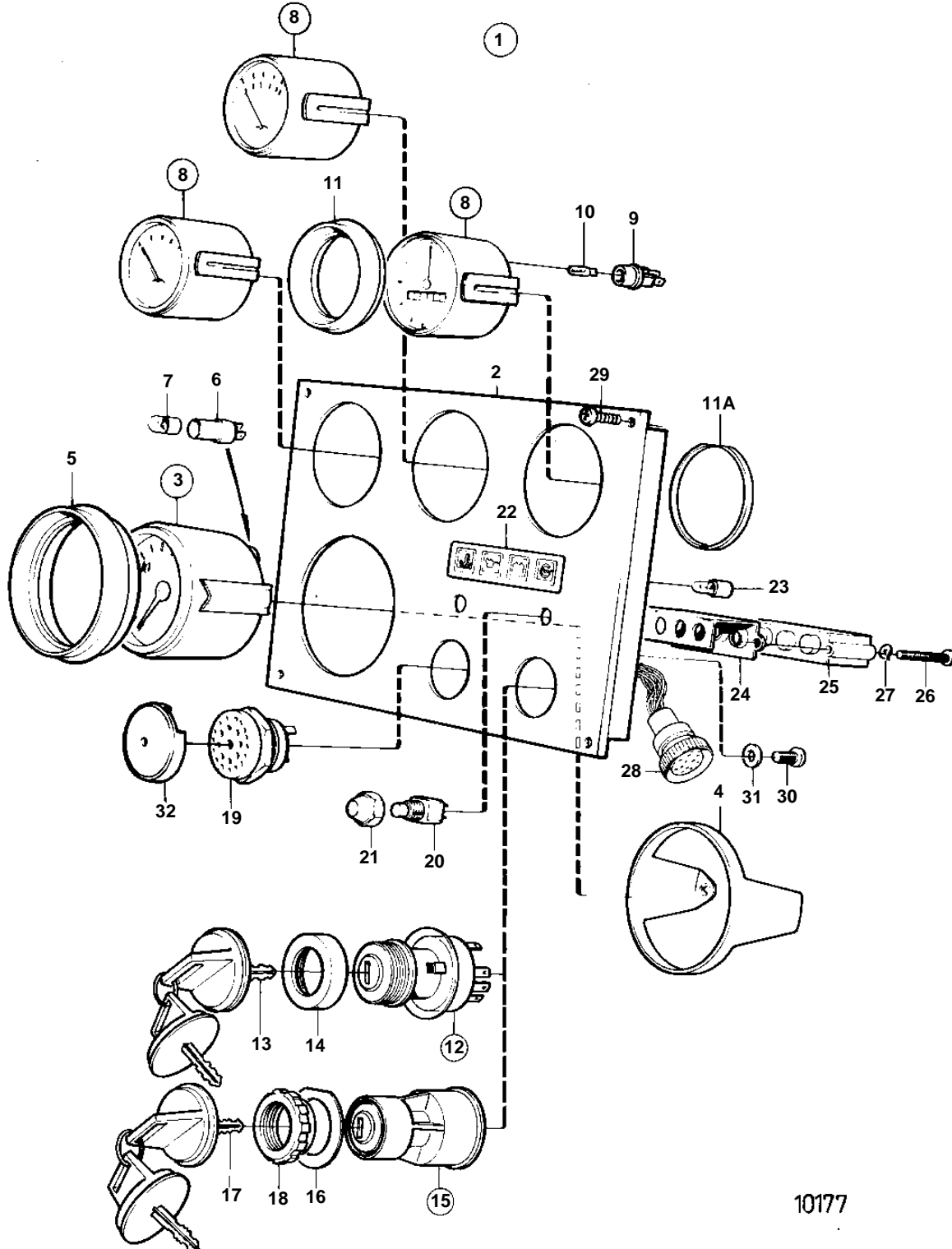

10177

## TAMD61A

REF	PART NO.	QTY	DESCRIPTION	SEE SEC.	NOTES
1	847978	1	Instrument panel		REPLACED BY 849935. Gold coloured stripe.
2	828588	1	· Instrument panel		Gold coloured stripe.
3	872040	1	· Instrument		
4	828558	1	· · Attaching ring		
5	858644	1	· Front ring		(828559)
6	808175	1	· Bulb socket		Fits bulb with base BA 7S.
7	182059	1	· Bulb		24V, 3W BA7S
8	863933	1	· Thermometer		
	863935	1	· Oil pressure gauge		For bulb with base W2X4,6d.
	873200	1	· Voltmeter		(863931)
9	863945	3	· · Bulb socket		For bulb with base W2X4,6d.. For instruments of early production should white bulb 182059 and bulb holder 808175 be mounted.
10	863947	3	· · Bulb		RED, 24V, 1,2W W2x4,6d. For instruments of early production should white bulb 182059 and bulb holder 808175 be mounted.
11	858643	3	· Front ring		
11A	828803	3	· Ring		
12	828778	1	· Starter switch		REPLACED BY 864277
13	828676	2	· · Key	SO	State key code when ordering.
14	1581184	1	· Round nut		
15	864277	1	· Starter switch		
16		1	· · Marking label		
17	859953	2	· · Key	SO	State key code when ordering.
			· · Bulletin 49-30	49-30-EN	Key P/N 859953
18	859955	1	· · Plastic nut		
19	828587	1	· Buzzer		
20	828584	1	· Switch		ALARM TEST
	828585	1	· Switch		INSTR. LIGHT
21	828586	2	· Nut		
22	858645	1	· Symbol strip		
23	828818	4	· Bulb		
24	828784	1	· Reflector		
25	873209	1	· Electronic unit		(828783)
26	941615	2	· Screw		
27	941904	2	· Spring washer		
28	828646	1	· Cable trunk		
29	828647	4	· Screw		
30	949947	1	· Screw		
31	941904	1	· Spring washer		
32	858795	1	· Protecting casing		