

TAMD163A-A

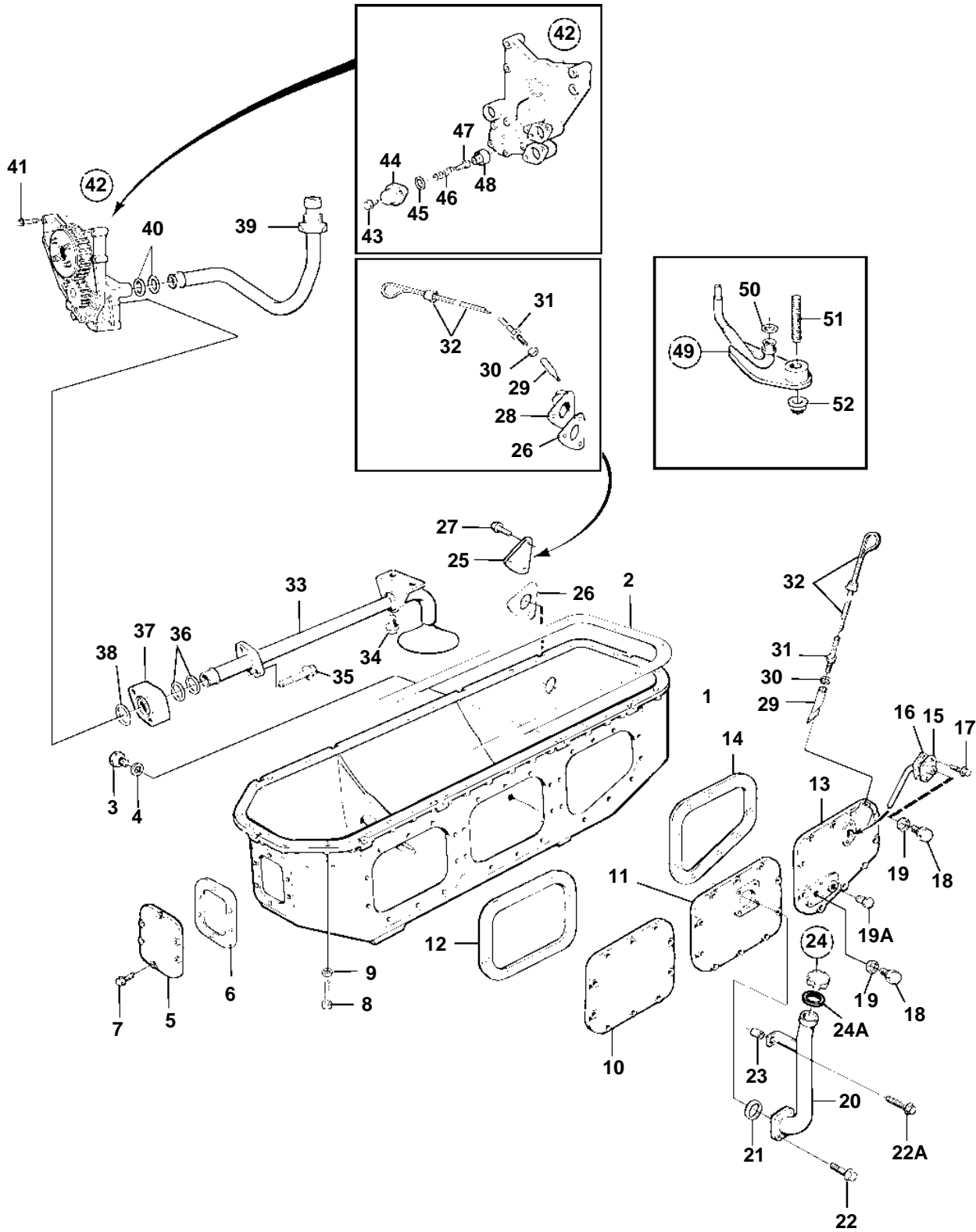

TAMD163A-A

REF	PART NO.	QTY	DESCRIPTION	SEE SEC.	NOTES
1	862554	1	Oil pan		
2	3827274	1	Gasket		(864775)
3	949175	1	Magnetic plug		
4	949329	1	Gasket		
5	849276	1	Cover		
6	849823	1	Gasket		
7	946671	36	Flange screw		
8	959223	44	Screw		
9	941907	44	Spring washer		
10	862626	1	Hatch		
11	849851	1	Hatch		
12	848912	2	Gasket		
13	862555	1	Cover		
14	862575	1	Gasket		
15	849793	1	Tube, draining		
16	862602	1	Gasket		
17	945444	2	Flange screw		
18	960632	2	Plug		
19	947624	2	Gasket		
19A	479956	1	Plug		
20	866936	1	Oil filler pipe		
21	843584	1	Sealing ring		
22	946173	4	Flange screw		
22A	946671	1	Flange screw		
23	862713	1	Sleeve		
24	1275403	1	Oil filler cap		
24A	1275379	1	Gasket		
25	849265	1	Cover		
26	849266	1	Gasket		
27	946173	3	Flange screw		
28	849249	1	Bracket		
29	862856	2	Tube		
30	11996	2	Gasket		
31	862572	2	Tube		
32	849975	2	Oil dipstick		
33	865093	1	Oil pump screen		
34	946440	2	Flange screw, reinforc. frame		
35	965180	2	Flange screw		
36	1543579	2	Sealing ring		
37	864968	1	Flange		
38	949722	1	O-ring		
39		1	Pipeincl nut and ferrule		EARLY TYPE
	3826186	1	Oil feed pipe, incl nut and ferrule		LATE TYPE
40	1543578	1	Sealing ring		EARLY TYPE
	1543578	2	Sealing ring		LATE TYPE
41	965186	4	Flange screw		
42	1556177	1	Oil pump		REPL BY 1556730
				404	
	1556730	1	Oil pump		
				3285	
43	945444	2	Flange screw		
44	1543608	1	Cover		
45	949659	1	O-ring		
46	1543630	1	Spring		
47	1543610	1	Peg		
48	1543964	1	Valve seat		
49	1556430	6	Jet, piston cooling		
50	955981	6	O-ring		
51	1556434	6	Stud		
52	948645	6	Lock nut		