

MD22P-B, TMD22-B, TAMD22P-B

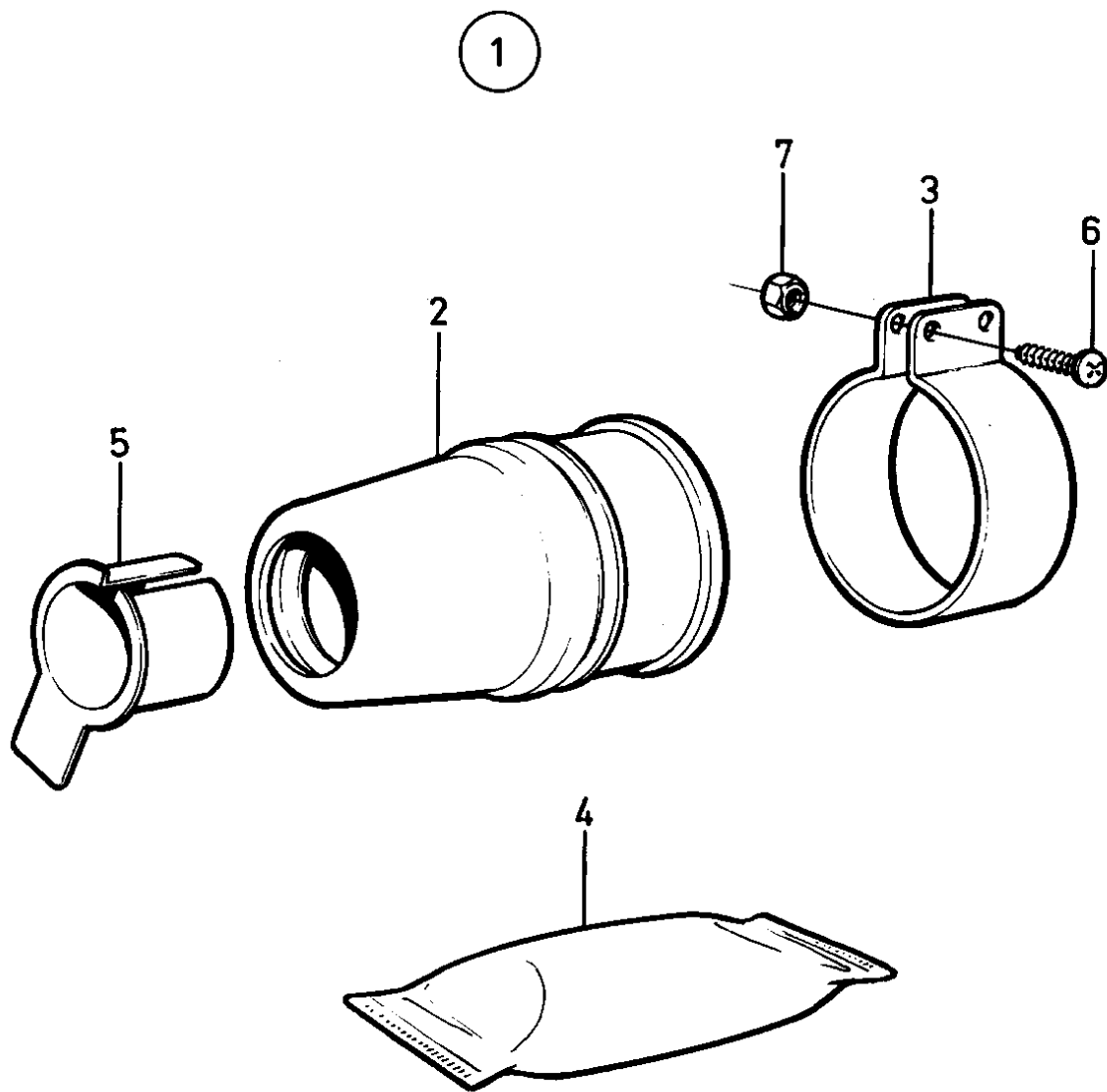

6147

MD22P-B, TMD22-B, TAMD22P-B

REF	PART NO.	QTY	DESCRIPTION	SEE SEC.	NOTES
1	828527	1	Seal Bulletin P-44-6-1	P-44-6-1-EN	Rubber Stuffing Box
2		1	· Sealing strip		
3	828528	1	· Clamp		
4	828250	1	· Grease		
5		1	· Sleeve		
6	963684	2	· Screw		
7	966170	2	· Nut		