

MD22L-B, MD22P-B, TMD22-B

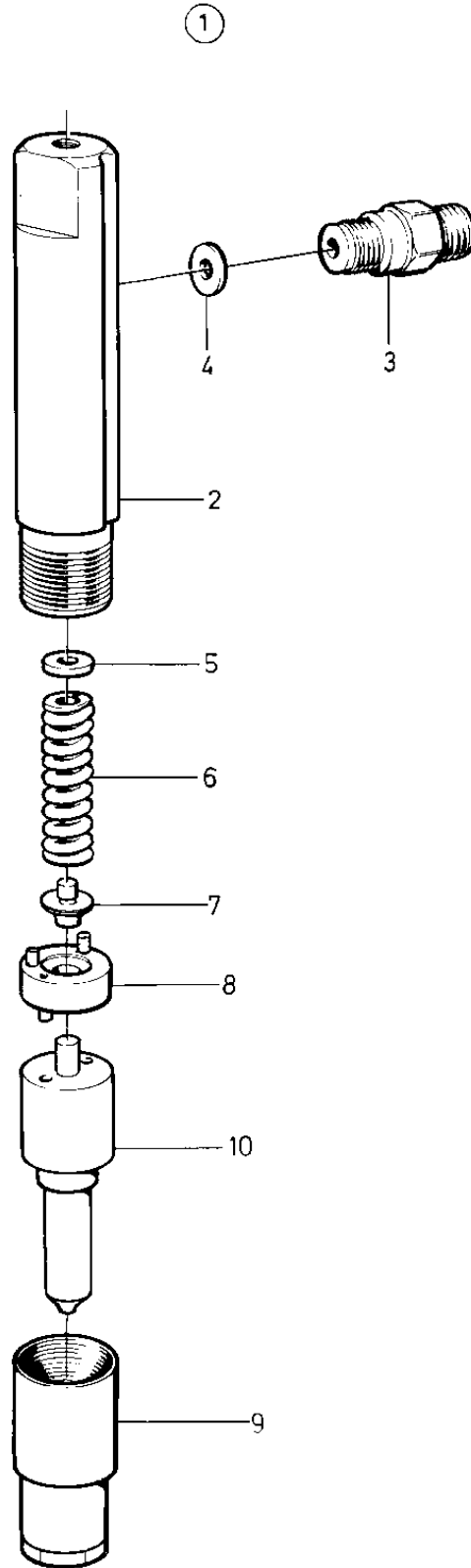

9688

MD22L-B, MD22P-B, TMD22-B

REF	PART NO.	QTY	DESCRIPTION	NOTES
1	861323	1	Injector	
	3803294	1	Injector, exch	Exchange unit
2		1	· Nozzle retainer	
3	6211991	1	· · Pressure pipe connec	
4	242523	1	· · Washer	
5	6211975	X	· · Shim	TH = 0,30mm
	860292	X	· · Shim	TH = 0,42mm
	6211977	X	· · Shim	TH = 0,44mm
	860293	X	· · Shim	TH = 0,46mm
	860294	X	· · Shim	TH = 0,48mm
	860295	X	· · Shim	TH = 0,50mm
	860296	X	· · Shim	TH = 0,52mm
	6211979	X	· · Shim	TH = 0,54mm
	860297	X	· · Shim	TH = 0,56mm
	860298	X	· · Shim	TH = 0,58mm
	860299	X	· · Shim	TH = 0,60mm
	860300	X	· · Shim	TH = 0,62mm
	860301	X	· · Shim	TH = 0,64mm
	6211984	X	· · Shim	TH = 0,66mm
	860302	X	· · Shim	TH = 0,68mm
	860303	X	· · Shim	TH = 0,70mm
	860304	X	· · Shim	TH = 1,00mm
	860305	X	· · Shim	TH = 1,28mm
	860306	X	· · Shim	TH = 1,56mm
6	6211990	1	· · Compression spring	
7	6211989	1	· · Spring disc	
8	6211993	1	· · Intermediate section	
9		1	· · Nut	
10	861415	1	· Nozzle	