

COMMON

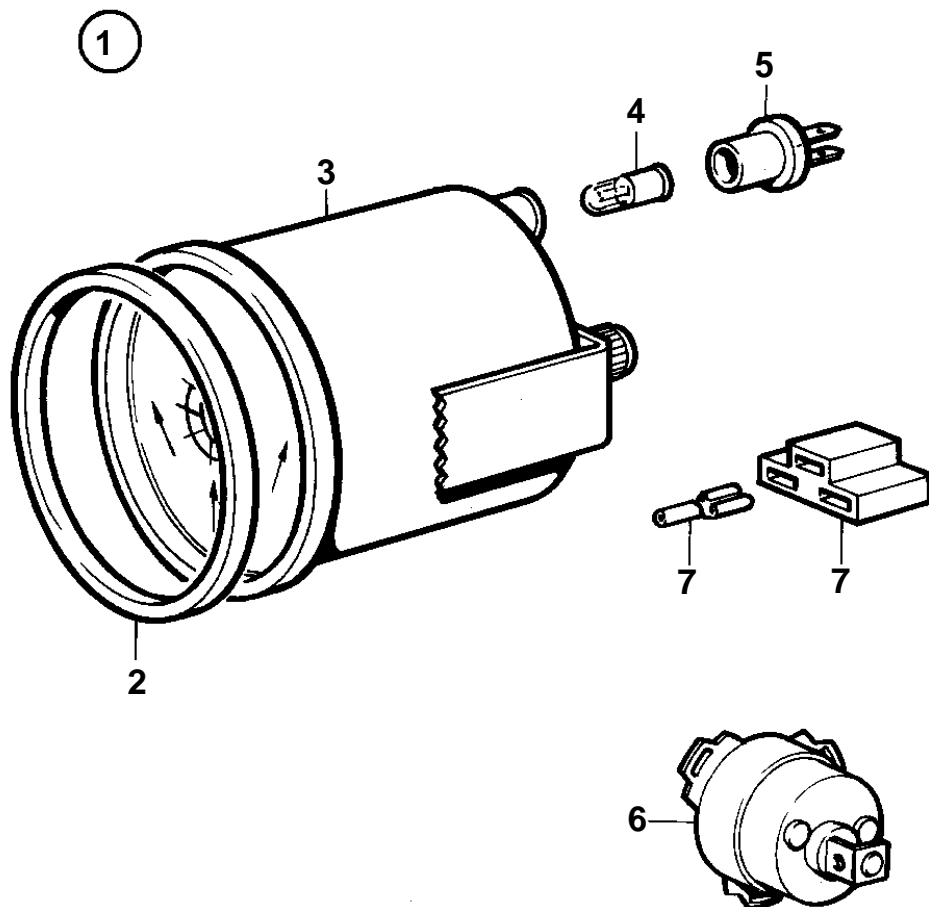

10036

COMMON

REF	PART NO.	QTY	DESCRIPTION	SEE SEC.	NOTES
1	858884	1	Rudder indicator kit		REPLACED BY 1140465
2	858643	1	· Front ring		
3	863944	1	· Rudder indicator		(828698)
4	863946	1	· · Bulb		
5	863945	1	· · Bulb socket		For instrument 828698 should white bulb 19923 and socket 808175 be mounted.
6	837772	1	· Position sensor		
7		X	· Electrical materials	1963	