

MD2010A

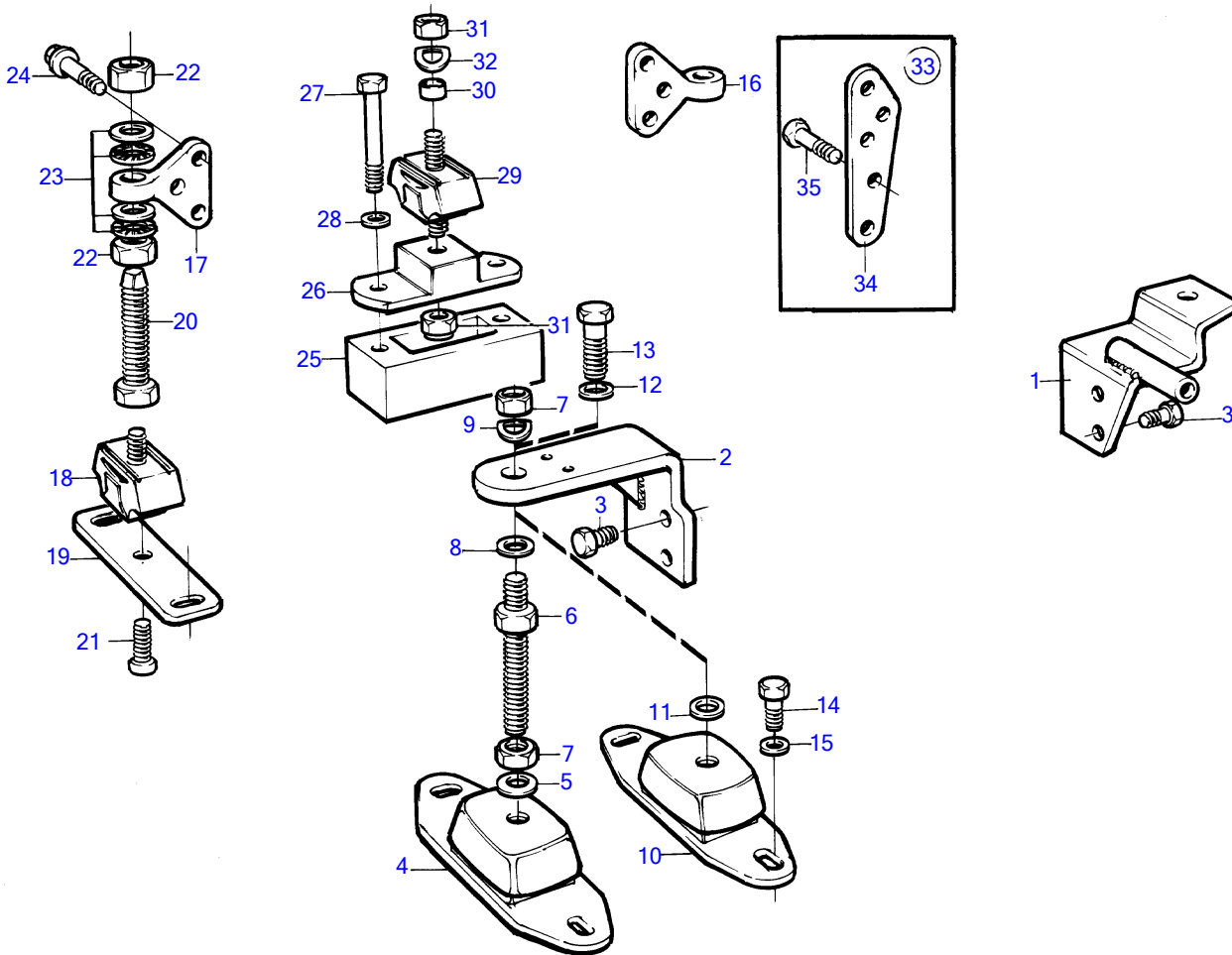

11672

MD2010A

REF	PART NO.	QTY	DESCRIPTION	NOTES
1	3580113	1	Engine mountings, front	P
2	3580114	1	Engine mountings, front	S.B
3	3580115	4	Screw	
4	861460	2	Rubber cushion	
5	955900	2	Washer	
6	861431	2	Adjusting screw	
7	955821	4	Hexagon nut	
8	955900	2	Washer	
9	941912	2	Spring washer	
16	860343	1	Engine bracket, rear	P
17	860344	1	Engine bracket, rear	S.B
18	838262	2	Rubber element	
19	838263	2	Attaching plate	
20	838264	2	Adjuster bolt	
21	949149	2	Hex. socket screw	
22	955806	4	Hexagon nut	
23	829893	8	Lock washer	
24	965185	6	Flange screw	
33	(858566)	1	Bracket kit	For deep engine installation., Obsolete part
34	858550	1	• Anchorage, rear	For deep engine installation., P
	858551	1	• Anchorage, rear	For deep engine installation., S.B
35	970948	4	• Hexagon screw	L=30mm
	970950	4	• Hexagon screw	L=40mm
	970954	2	• Hexagon screw	L=60mm