

MD2040A

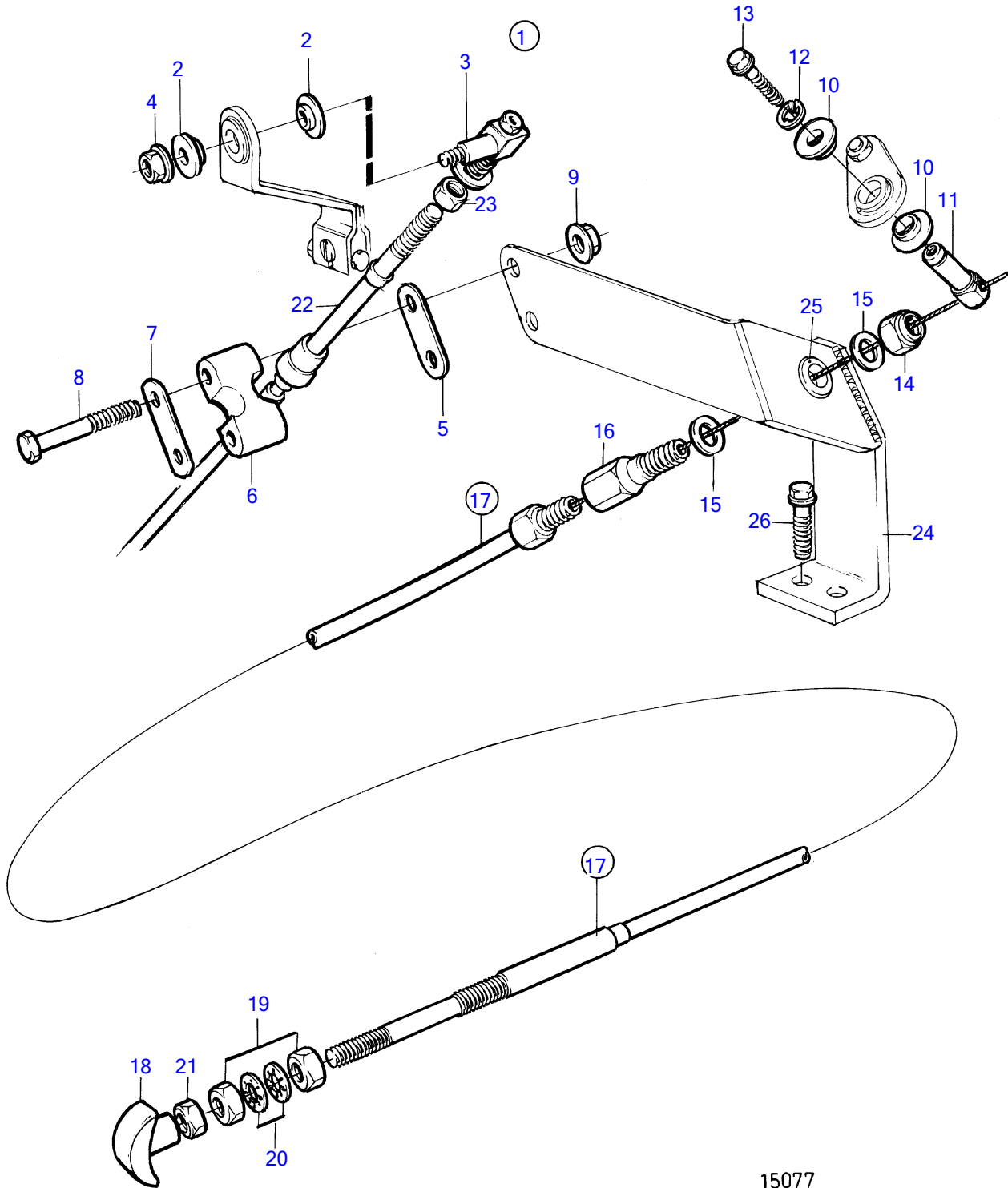

15077

MD2040A

REF	PART NO.	QTY	DESCRIPTION	SEE SEC.	NOTES
1		1	Connector kit		
2	843105	2	• Spacer washer		
3	840692	1	• Cube		
4	946577	1	• Lock nut		
5	872076	1	• Washer		
6	872074	1	• Retainer		
7	819068	1	• Washer		
8	955251	2	• Hexagon screw		
9	946577	2	• Lock nut		
10	843105	2	• Spacer washer		
11	861479	1	• Cable clamp		
12	951669	1	• E-circlip		
13	955229	1	• Hexagon screw		
14	945467	1	• Lock nut		(950353)
15	955894	2	• Washer		
16	829070	1	• Cable lock		
17	825765	1	Choke control		L=3,3m
			• Bulletin P-27-6-2	P-27-6-2-EN	End of Production - Stop Cables
17	825764	1	Choke control		L=6,9m
			• Bulletin P-27-6-2	P-27-6-2-EN	End of Production - Stop Cables
18	(829241)	1	• Handle		Obsolete part
19	955857	2	• Hexagon nut		
20	955950	2	• Toothed washer		
21	955844	1	• Hexagon nut		
22		1	Control cable	231	
23		1	• Nut		
24	3580606	1	Anchorage		
25	843109	1	Bushing		
26	861844	2	Screw		