

1

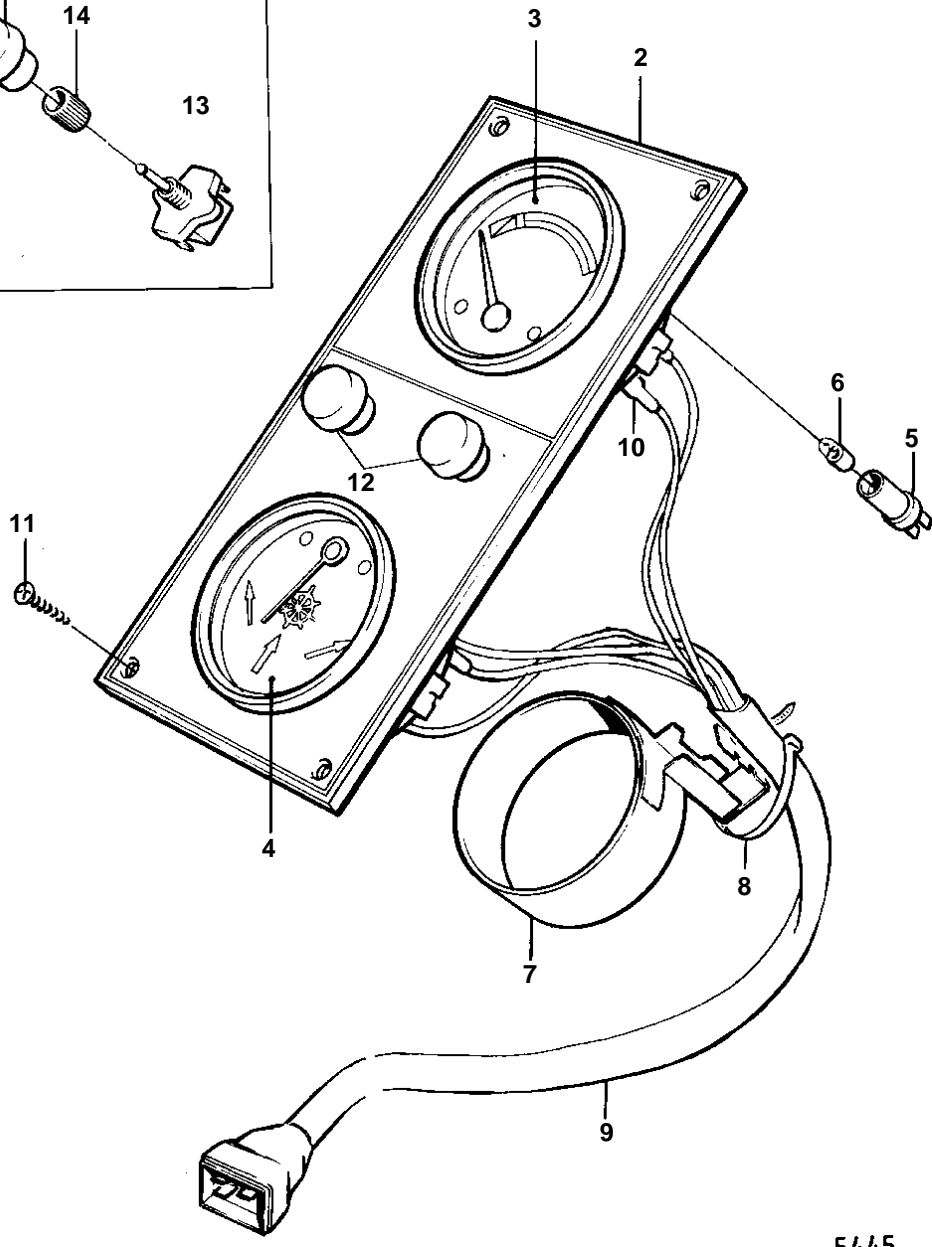
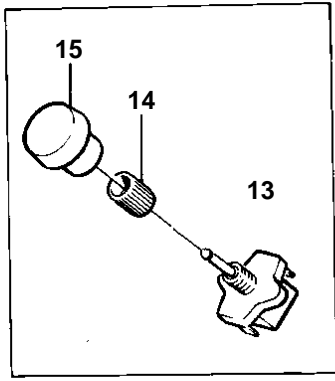

5445

REF	PART NO.	QTY	DESCRIPTION	SEE SEC.	NOTES
1	837995	1	Instrument panel		12V
2	837539	1	· Instrument plate		
3	837762	1	· Tank gauge		
4	837732	1	· Rudder pos instrumen		
5	808175	2	· Bulb socket		
6	19923	2	· Bulb		
7	837859	1	· Anchorage		
8	948210	X	· Strip clamp		(827353)
9	837998	1	· Cable trunk		
10		X	· · CABLE AND CABLE TERMINALS	030-1950	
11	944540	4	· Screw		
12	845071	2	· Plug		
13	875819	X	Switch		
14	843002	X	Nut		
15	837726	X	Knob		