

COMMON

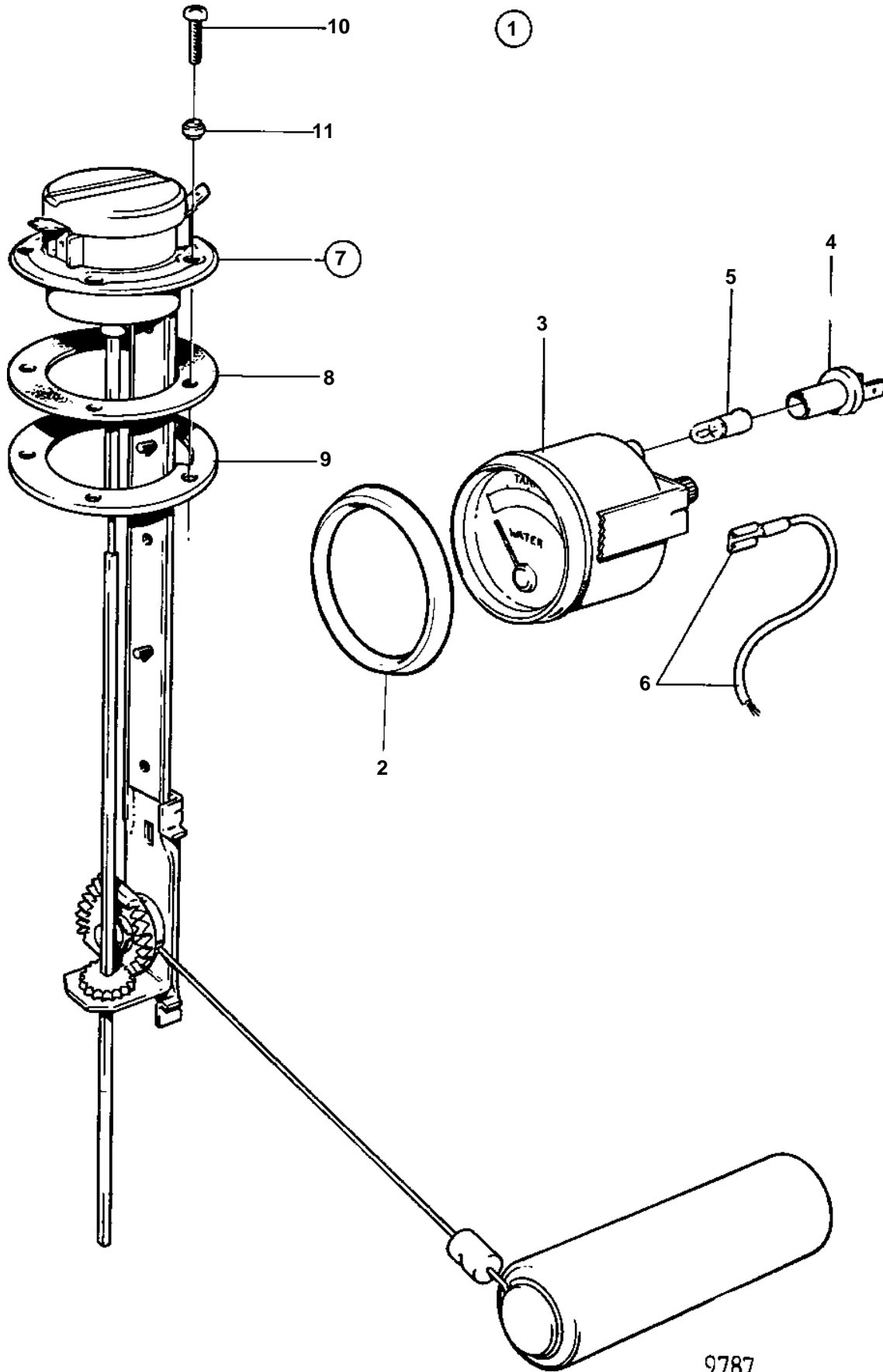

COMMON

REF	PART NO.	QTY	DESCRIPTION	SEE SEC.	NOTES
1	1140462	1	Water level gauge ki		(858881)
2	858643	1	· Front ring		
3	863942	1	· Water level gauge		
4	863945	1	· · Bulb socket		For instrument of earlier production should white bulb 19923 and socket 808175 be mounted.
5	863946	1	· · Bulb		RED. For instrument of earlier production should white bulb 19923 and socket 808175 be mounted.
6		X	· Electrical materials	1963	
7	834389	1	· Sender		
8	89865	1	· · Gasket		
9	834480	1	· · Flange		
10	956078	4	· · Screw		
	956081	1	· · Screw		
11	834481	5	· · Gasket		