

COMMON

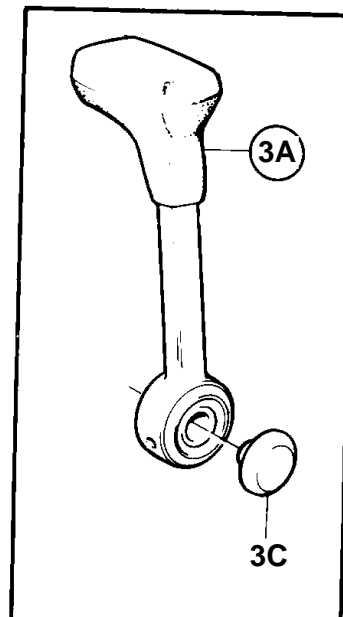
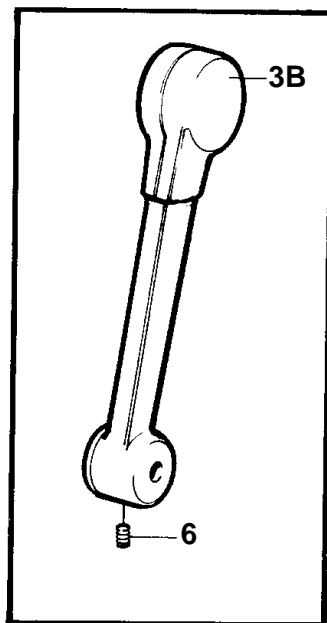
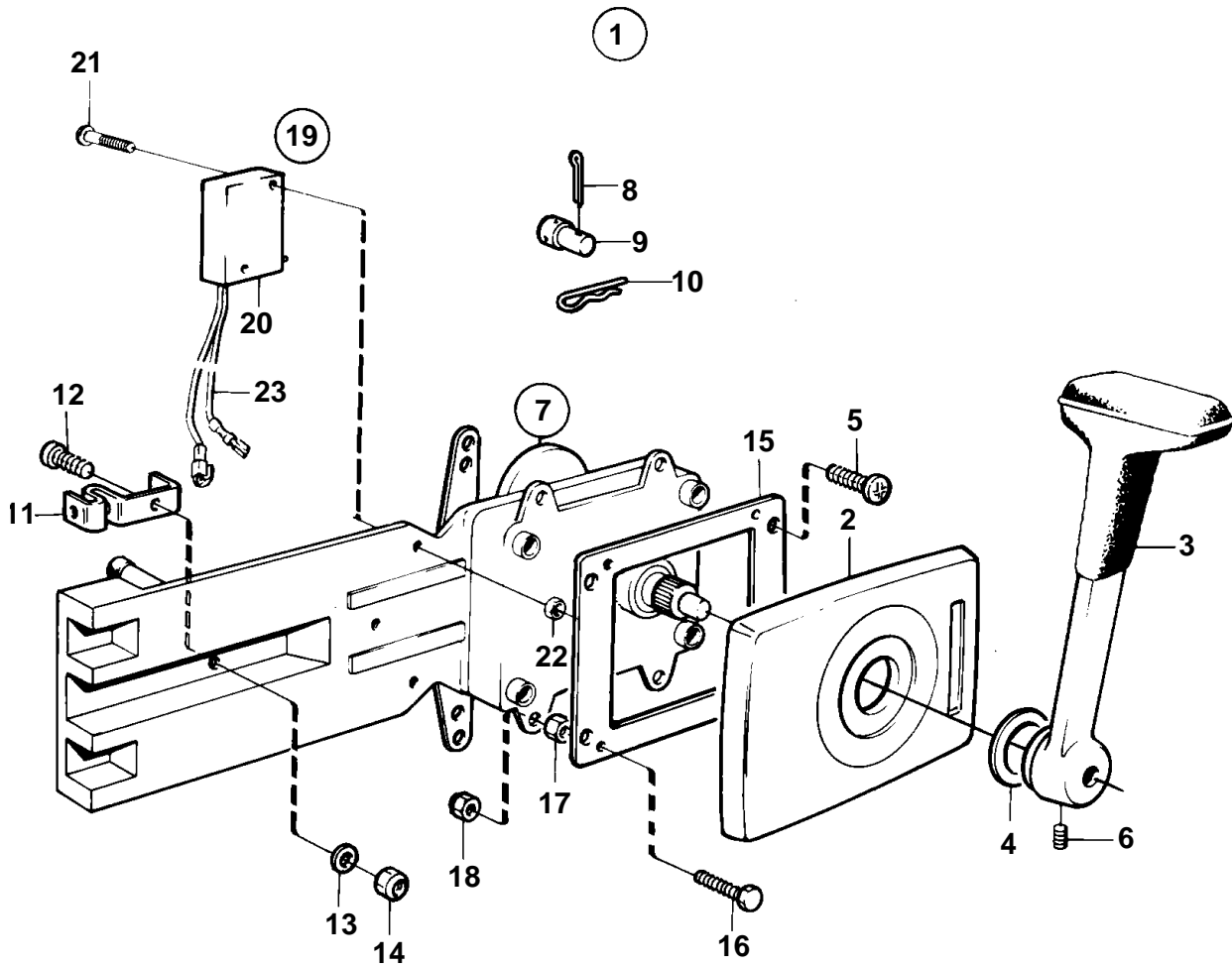

10315

COMMON

REF	PART NO.	QTY	DESCRIPTION	SEE SEC.	NOTES
1	1140090	1	Mounting kit		PC841
2	853713	1	· Cover		
3A	852347	1	· Lever		
				090-2650	
3C	853004	1	· Push button		
5	961330	4	· Screw		
7	1140095	1	Control mechanism		
8	17253	2	· Cotter pin		
9	839638	2	· Cube		
10	852924	1	· Clip		
11	853423	1	· Retainer		
12	839664	1	· Screw		
13	940275	1	· Washer		
14	946435	1	· Lock nut		
15		1	· ATTACHING PLATE		NOT TO BE USED TOGETHER WITH INSTALLATION KIT 851605
16	963548	4	· Screw		
17		4	· NUT		
18	946435	4	· Lock nut		
19	855352	1	Neutral posit contac		
20	850200	1	· Switch		
21	946177	2	· Screw		
22	947536	2	· Nut		
23		X	· CABLES AND TERMINALS		SEE GROUP 3
		X	· ELECTRICAL MATERIALS		SEE GROUP 3