

KAMD300-A

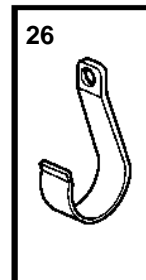
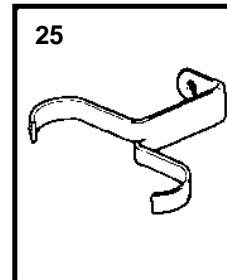
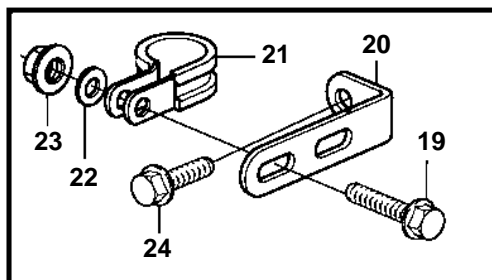
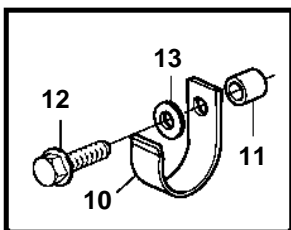
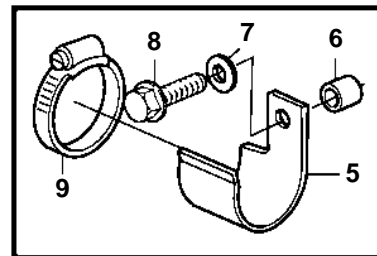
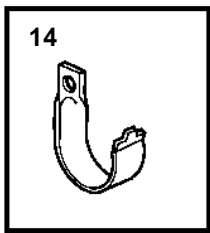
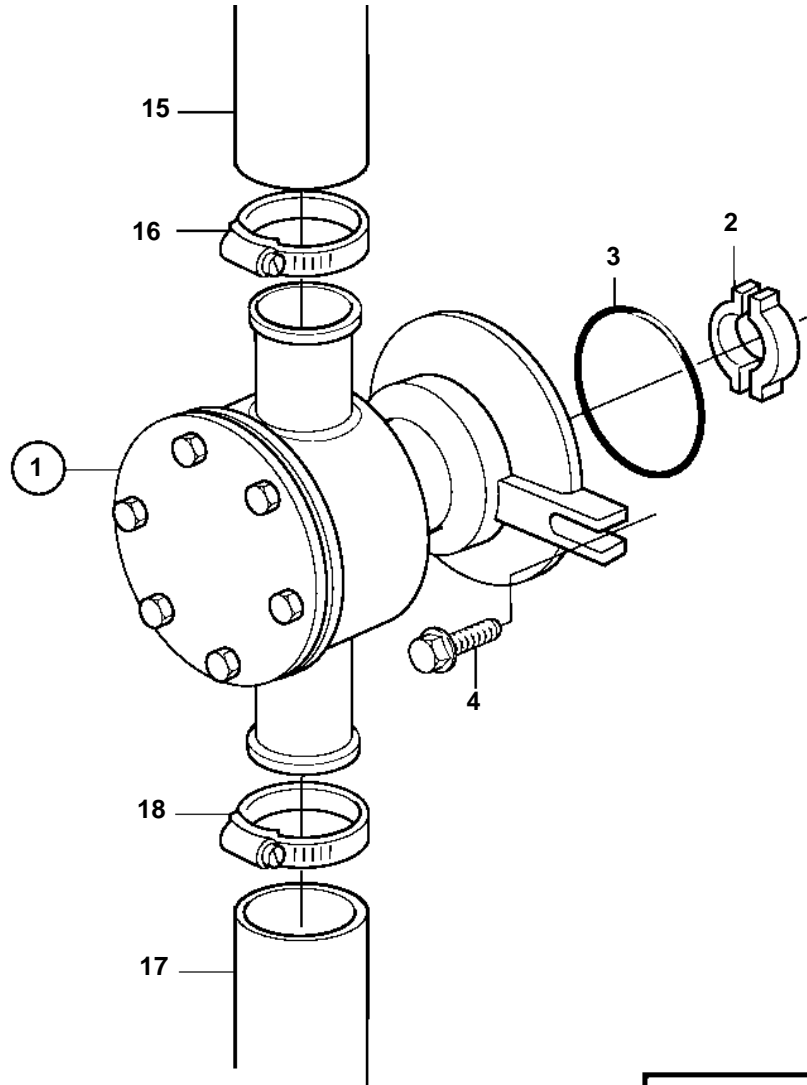

KAMD300-A

REF	PART NO.	QTY	DESCRIPTION	SEE SEC.	NOTES
1	3583095	1	Sea water pump	3400	
2	858467	1	Companion flange		
3	968971	1	O-ring		
4	945444	2	Flange screw		
5	3580758	1	Bracket		
6	843075	1	Sleeve		
7	955894	1	Washer		
8	945444	2	Flange screw		
9	961669	1	Hose clamp		
10	857045	2	Clamp		
11	843075	1	Sleeve, inlet		L=16mm
	1660462	1	Spacer sleeve		
12	965180	1	Flange screw		L=60mm
13	955894	2	Washer		
14	834974	1	Clamp		
15	861335	1	Hose		Sea water pump-intercooler.
16	943476	1	Hose clamp		
17	861738	1	Hose		Reverse gear-sea water pump.
18	961669	2	Hose clamp		
19	946544	1	Flange screw		
20	965558	1	Bracket		
21	967645	1	Clamp		
22	955893	1	Washer		
23	949278	1	Lock nut		
24	947760	1	Flange screw		
25	3580794	1	Bracket		
26	3580798	1	Clamp		