

D8A1-A MP, D8A2-A MP, D8A3-A MP, D8A4-A MP

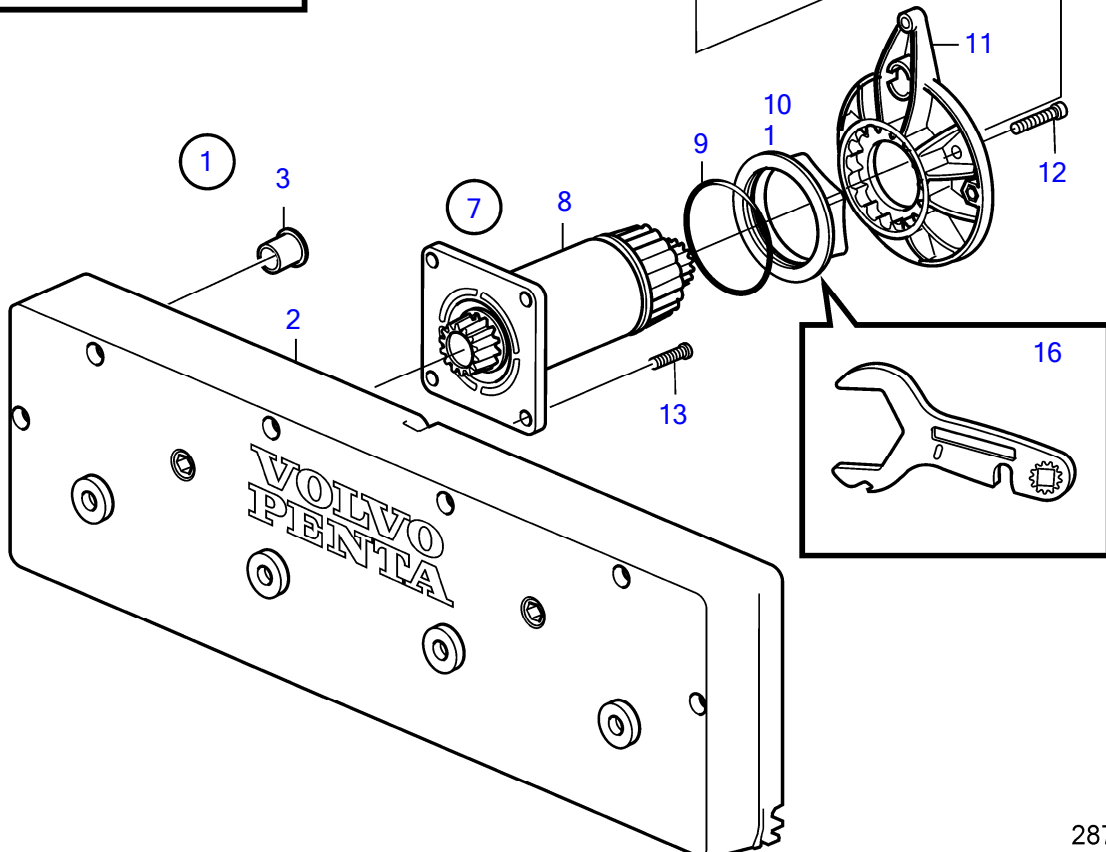
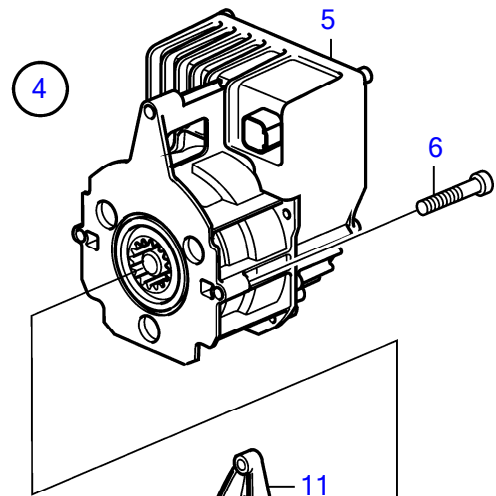
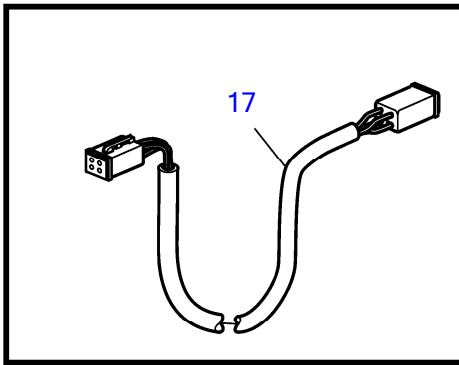
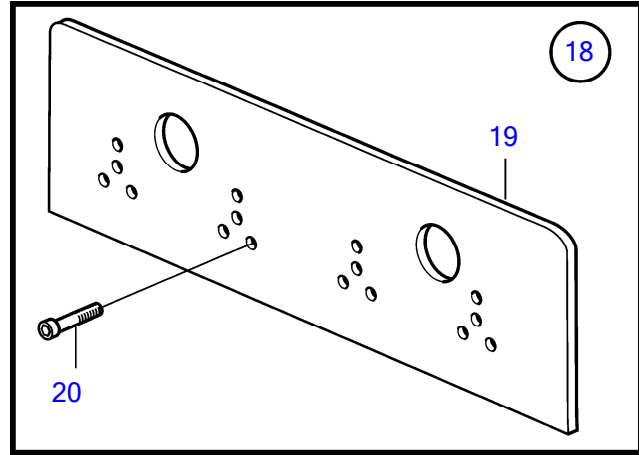
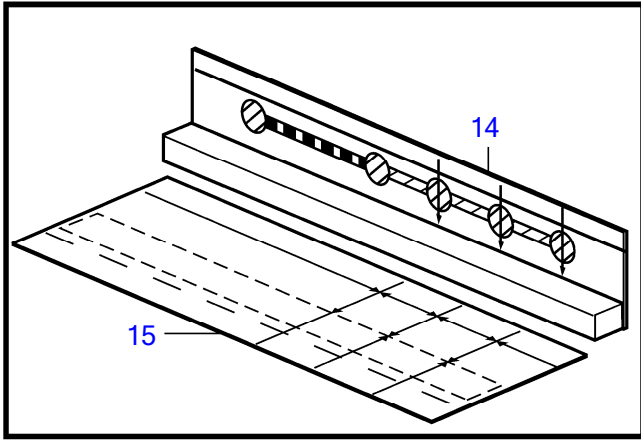

28719

D8A1-A MP, D8A2-A MP, D8A3-A MP, D8A4-A MP

REF	PART NO.	QTY	DESCRIPTION	NOTES
1		1	Kit	
2	21947168	2	• Kit	
		1	• • Trimming plate	
3	22173239	6	• • Sealing plug	
4	21948237	2	• Kit	
5	(21875630)	1	• • Servo unit	Obsolete part
6	997677	3	• • Hex. socket screw	
7	21888969	2	• Drive shaft kit	
8		1	• • Shaft	
9	22088469	1	• • O-ring	
10	21890405	1	• • Flange nut	
11	21888972	1	• • Drive plate	
12	21890471	3	• • Six point socket scr	
13	21955937	4	• • Six point socket scr	
14	21970434	1	• Drill template	
15	21970436	1	• Support	
16	21888526	1	• Wrench	
17	21875632	2	• Wiring harness	
18	22728821	1	Mounting plate kit	
19		2	• Mounting plate	
20	996642	12	• Hex. socket screw	