

D8A1-A MP, D8A2-A MP, D8A3-A MP, D8A4-A MP

1

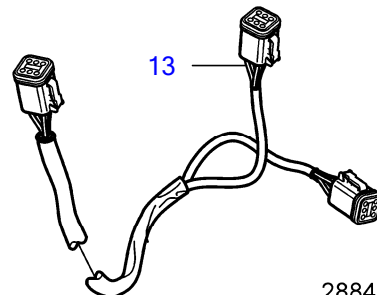
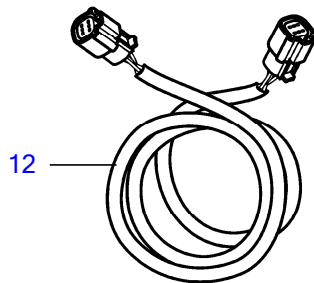
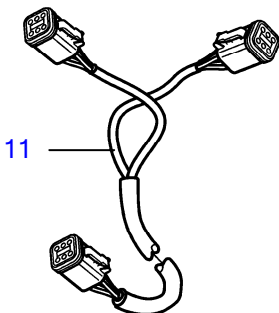
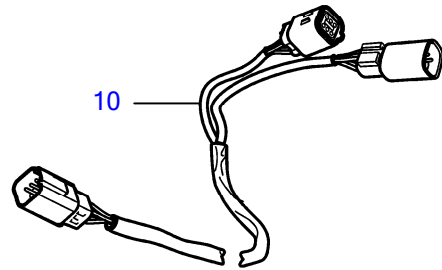
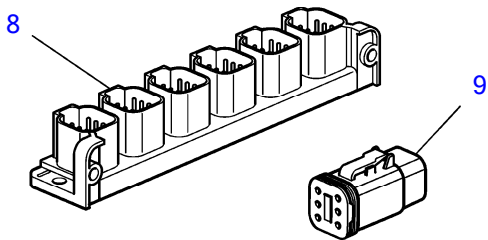
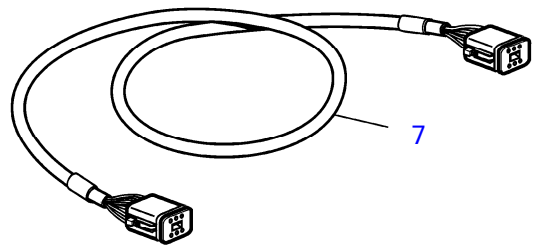
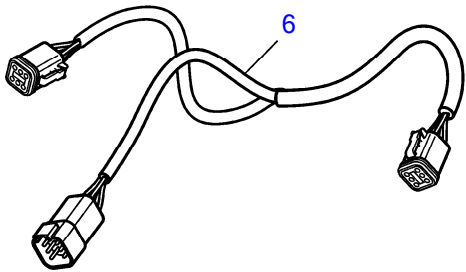
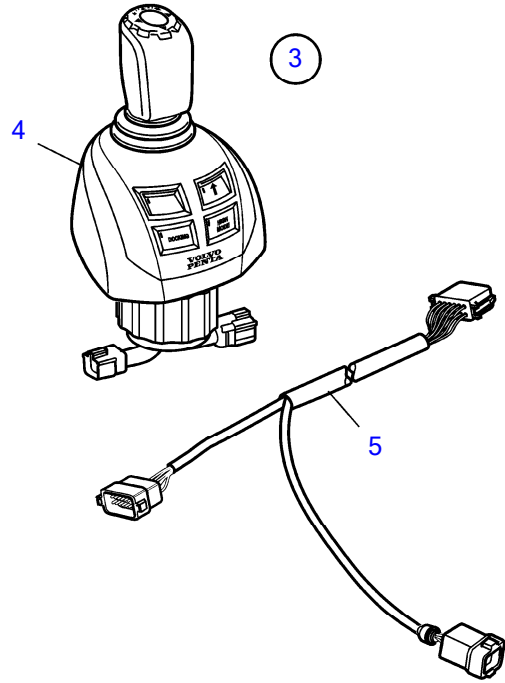
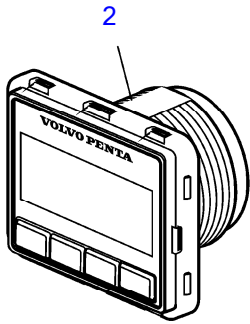

28847

D8A1-A MP, D8A2-A MP, D8A3-A MP, D8A4-A MP

REF	PART NO.	QTY	DESCRIPTION	SEE SEC.	NOTES
1		1	Kit, Docking Station Triple IPS		
2	22499273	1	• Display panel	41566	2,5" Flexidisplay Button Panel
3	22790933	1	• Control knob	41547	Obsolete part, Joystick Delux IPS, unit
	(22893918)	1	• Control knob, Type Approved Joystick IPS	41754	Obsolete part
4	22498703	1	• • Control knob		
			• Bulletin P-97-9-109	P-97-9-109-EN	RETROFIT OF DYNAMIC POSITIONING SYSTEM
4	22862204	1	• • Control knob		
5	21421926	2	• • Cable		
			• Bulletin P-97-9-109	P-97-9-109-EN	RETROFIT OF DYNAMIC POSITIONING SYSTEM
6	3588972	3	• Cable kit		
7	3886666	1	• Cable		
8	21469055	1	• Connection block		
9	3840433	4	• • Sealing plug		
10	21421941	2	• Cable		
11	21427460	1	• Cable		
12	21450563	2	• Cable		
13	21287072	1	• Wiring harness		