

D8A1-A MP, D8A2-A MP, D8A3-A MP, D8A4-A MP

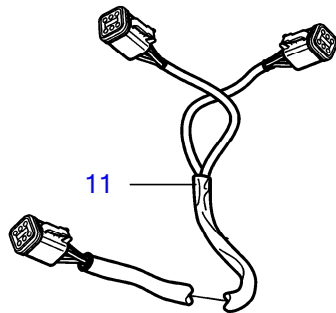
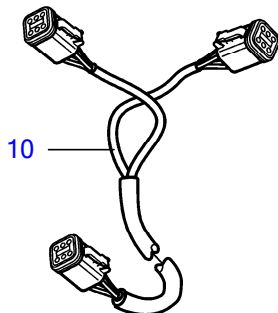
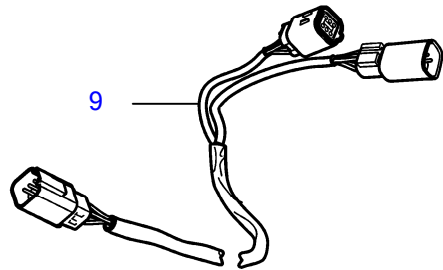
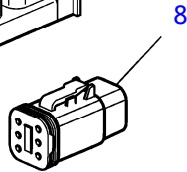
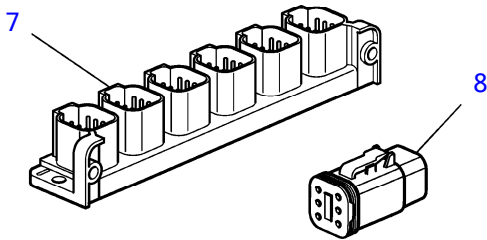
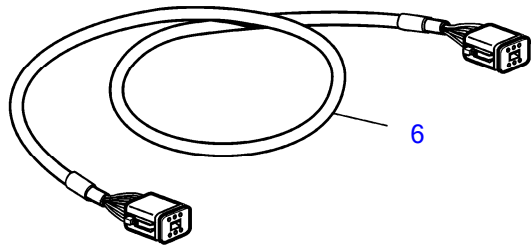
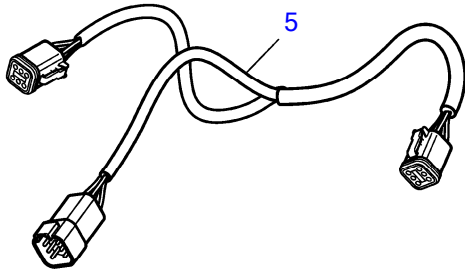
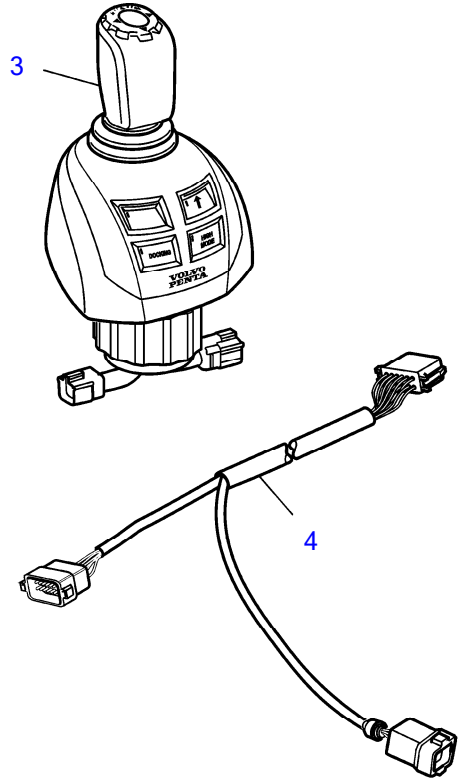
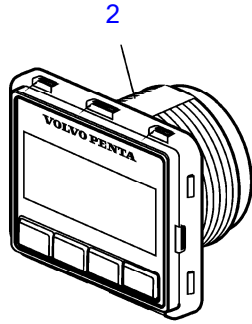

28848

D8A1-A MP, D8A2-A MP, D8A3-A MP, D8A4-A MP

REF	PART NO.	QTY	DESCRIPTION	SEE SEC.	NOTES
1		1	Kit, Docking Station Quad IPS		
2	22499273	1	• Display panel	41566	2,5" Flexidisplay Button Panel
3			• Control knob, Type Approved Joystick IPS	41754	
	22790933		• Control knob	41547	Obsolete part, Joystick Delux IPS, unit
	22498703	1	• • Control knob		
			• Bulletin P-97-9-109	P-97-9-109-EN	RETROFIT OF DYNAMIC POSITIONING SYSTEM
4	21421926		• • Cable		
			• Bulletin P-97-9-109	P-97-9-109-EN	RETROFIT OF DYNAMIC POSITIONING SYSTEM
5	3588972	4	• Cable kit		
6	3886666	1	• Cable		
7	21469055	1	• Connection block		
8	3840433	4	• • Sealing plug		
9	21421941	2	• Cable		
10	21450563	2	• Cable		
11	21287072	1	• Wiring harness		