

D8A1-A MP, D8A2-A MP, D8A3-A MP, D8A4-A MP

1

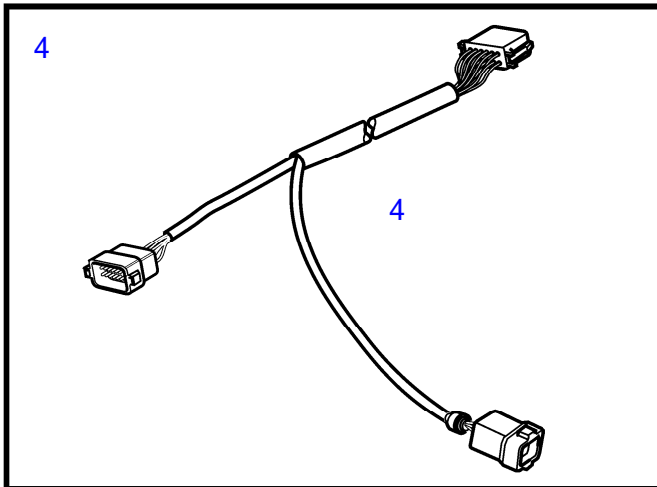
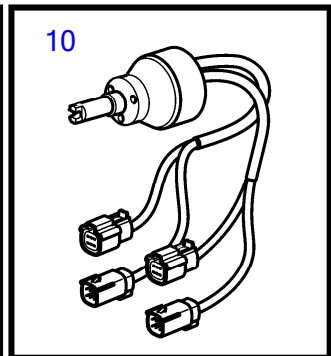
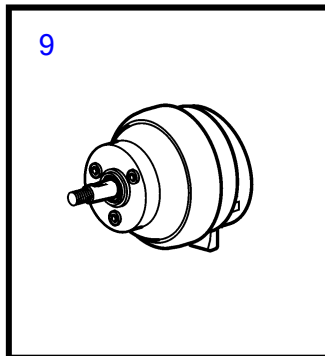
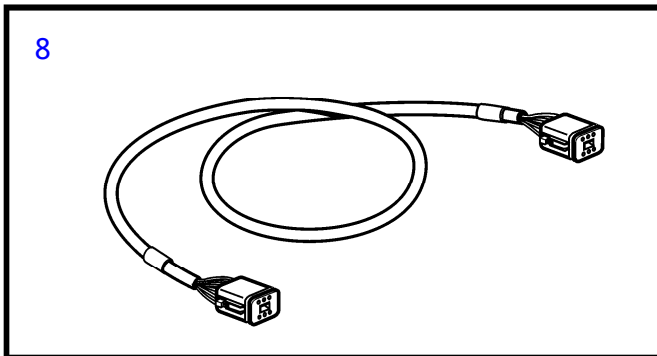
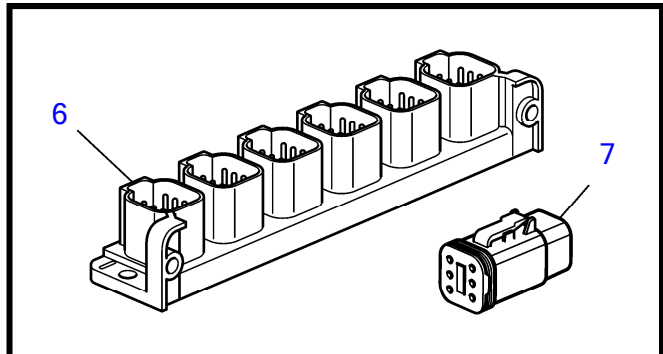
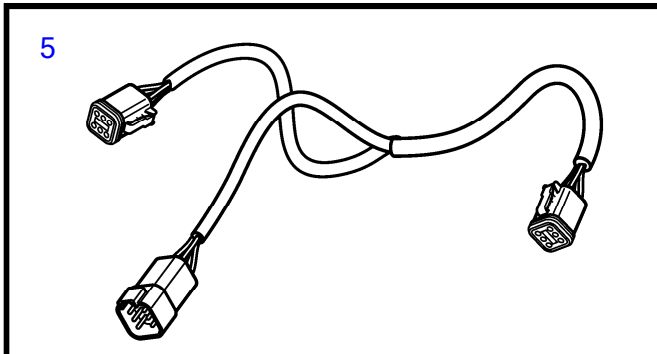
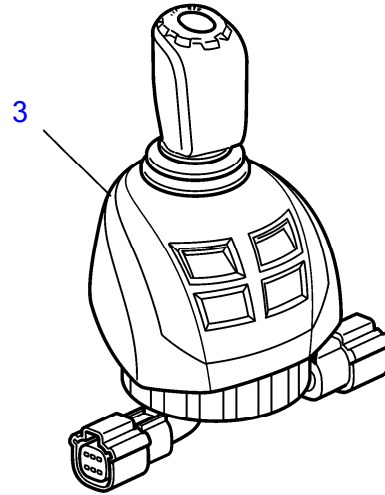
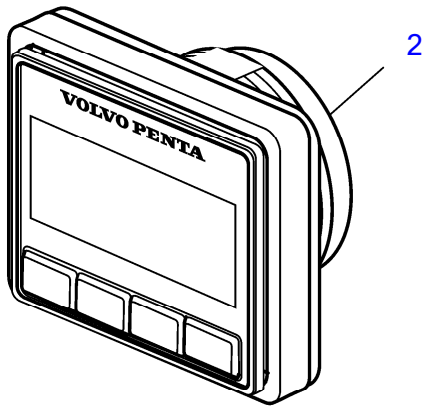

29543

D8A1-A MP, D8A2-A MP, D8A3-A MP, D8A4-A MP

REF	PART NO.	QTY	DESCRIPTION	SEE SEC.	NOTES
1		1	Kit, Secondary Station for Inboard		
		1	Kit, Secondary Station for IPS		
		1	Kit, Secondary Station for Aquamatic		
		1	Evc docking station		
2	22499273	1	• Display panel	41566	
3	22783418	1	• Control knob, Joystick for Inboard	41547	
	22498703	1	• Control knob, Joystick for IPS	41547	
			• Bulletin P-97-9-109	P-97-9-109-EN	RETROFIT OF DYNAMIC POSITIONING SYSTEM
3	22498686	1	• Control knob, Joystick Delux Aquamatic	41547	Replaced by 22893899
	22893899	1	• Control knob, Joystick Delux Aquamatic		
	(22893918)	1	• Control knob, Type Approved Joystick IPS	41754	Obsolete part
	22862204	1	• • Control knob		
4	21421926	2	• • Cable		
			• Bulletin P-97-9-109	P-97-9-109-EN	RETROFIT OF DYNAMIC POSITIONING SYSTEM
5	3588972	2	• Cable kit		
6	21469055	1	• Connection block		
7	3840433	1	• • Sealing plug		
8	3886666	4	• Cable		
9	22299003	1	• Steering wheel adjus		
10	21469560	1	• Steering wheel hub		Replaced by 22353839
	22353839	1	• Steering wheel hub		