

D65A-MT, D65A-MS

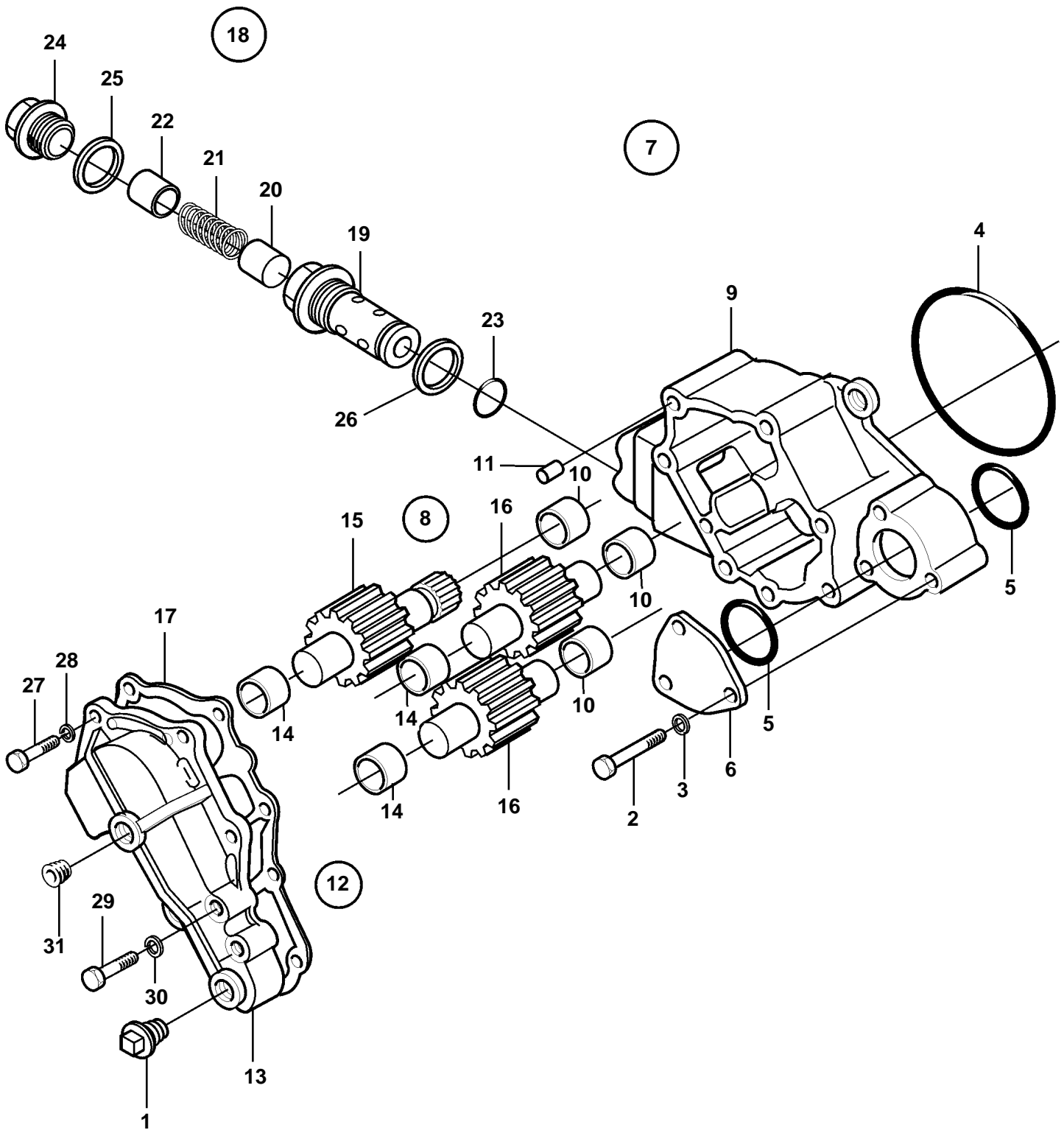

18516

D65A-MT, D65A-MS

REF	PART NO.	QTY	DESCRIPTION
1	3832105	1	Plug
2	3832089	3	Screw
3	3832245	3	Spring washer
4	3831580	1	O-ring
5	3831578	2	O-ring
6	3833390	1	Cover
7	3837647	1	Oil pump
8	3833145	1	· Oil pump housing
9		1	· · Oil pump housing
10		3	· · Bushing
11		2	· · Pin
12	3833355	1	· Cover
13		1	· · Cover
14		3	· · Bushing
15	3833590	1	· Drive gear
16	3833593	2	· Gear
17	3833920	1	· Gasket
18	3834824	3	· Valve
19		3	· · Valve housing
20	3834822	3	· · Valve
21	3834650	3	· · Spring
22	3834730	3	· · Adjusting sleeve
23	3833843	3	· · O-ring
24	3834271	3	· · Plug
25	3831598	3	· · Sealing washer
26	3831947	3	· Sealing washer
27	3832047	6	· Screw
28	3832233	6	· Spring washer
29	3832051	2	· Screw
30	3832233	2	· Spring washer
31	3831862	1	· Plug