

D6-300A-F, D6-300D-F (MC), D6-300I-F, D6-330A-F, D6-330D-F, D6-330I-F, D6-370A-F, D6-370D-F, D6-370I-F, D6-400A-F, D6-435D-F, D6-435I-SC-F, D6-435I-TC-F, D6-435I-WJ-F

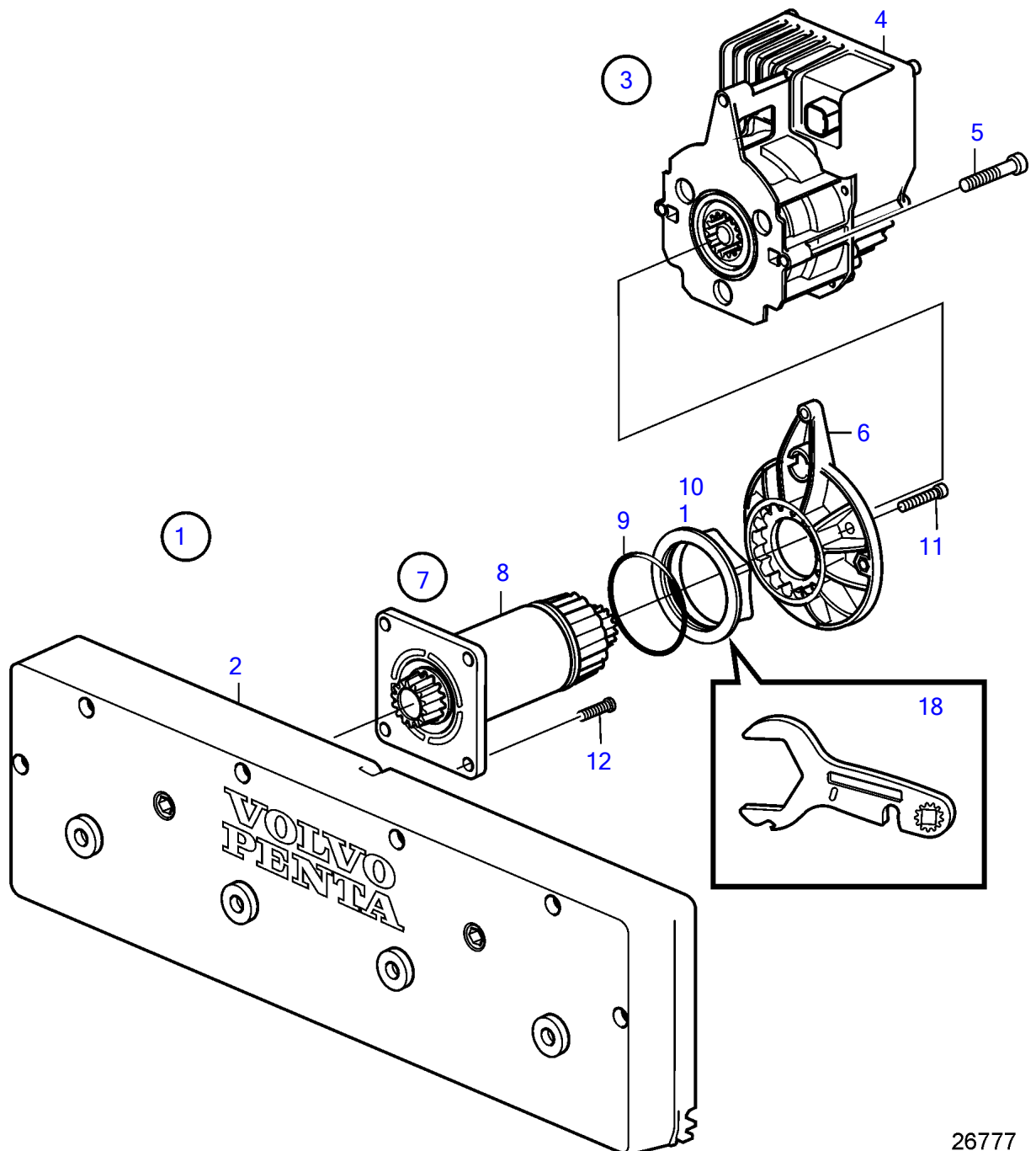
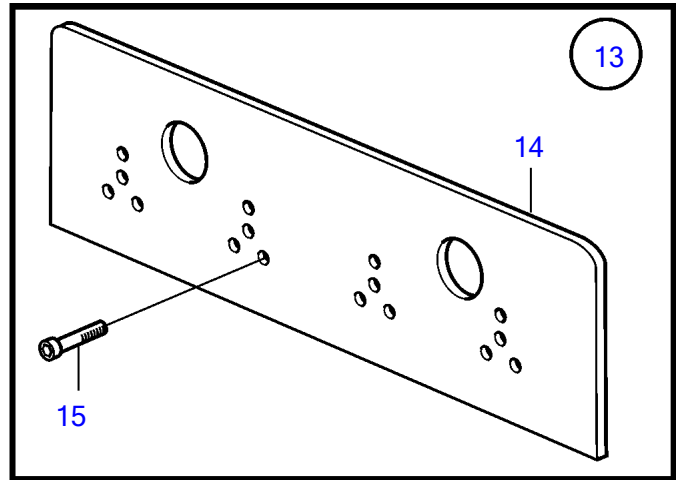
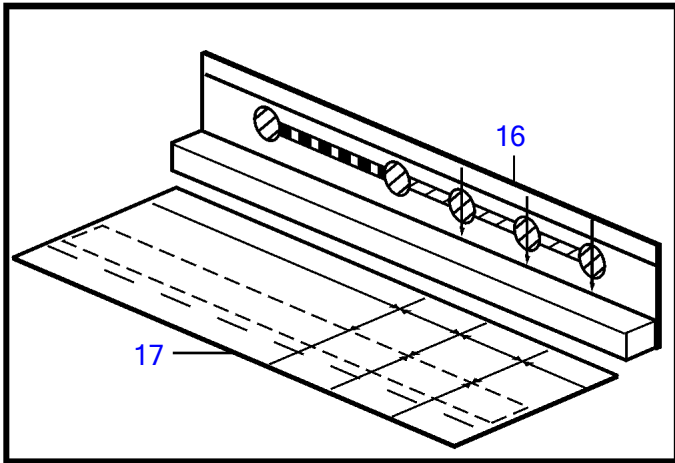

26777

D6-300A-F, D6-300D-F (MC), D6-300I-F, D6-330A-F, D6-330D-F, D6-330I-F, D6-370A-F, D6-370D-F, D6-370I-F, D6-400A-F, D6-435D-F, D6-435I-SC-F, D6-435I-TC-F, D6-435I-WJ-F

REF	PART NO.	QTY	DESCRIPTION	NOTES
1		1	Kit	
2	21947166	1	• Kit	
		1	• • Trimming plate	
3	21948237	2	Kit	
4	(21875630)	1	• Servo unit	Obsolete part
5	997677	3	• Hex. socket screw	
6	21888972	2	• Drive plate	
7	21888969	1	Drive shaft kit	
8		1	• Shaft	
9	22088469	1	• O-ring	
10	21890405	1	• Flange nut	
11	21890471	3	• 6 point socket screw	
12	21955937	4	• 6 point socket screw	
13	21889194	1	Kit	
14		1	• Guide plate	
15	996642	8	• Hex. socket screw	
16	21970434	1	Drill template	
17	21970436	1	Support	
18	21888526	1	Wrench	