

D6-330D-F, D6-370D-F, D6-435D-F

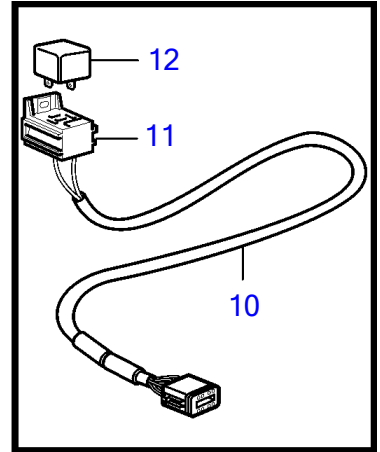
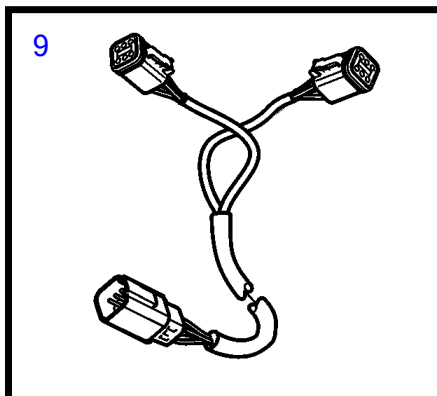
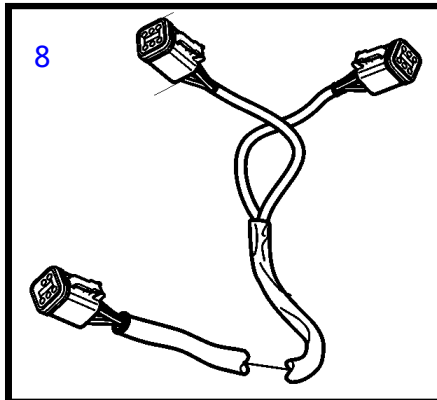
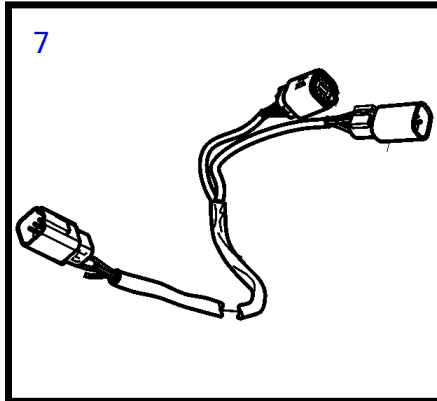
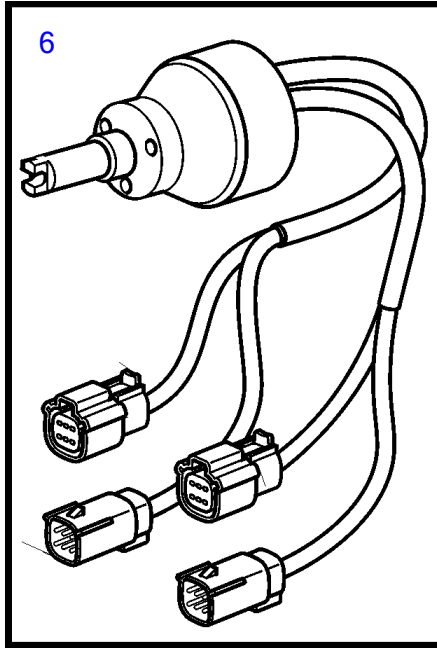
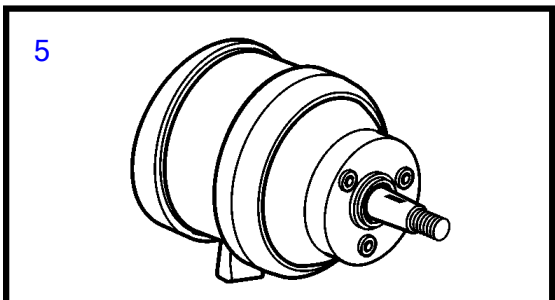
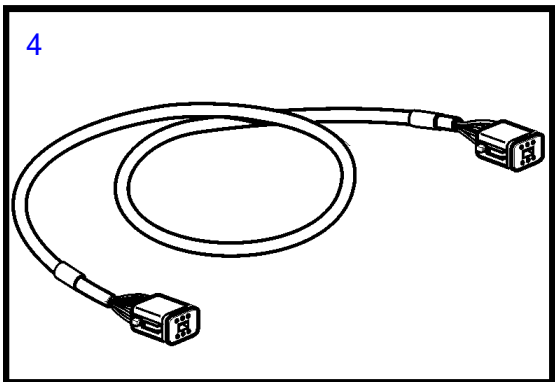
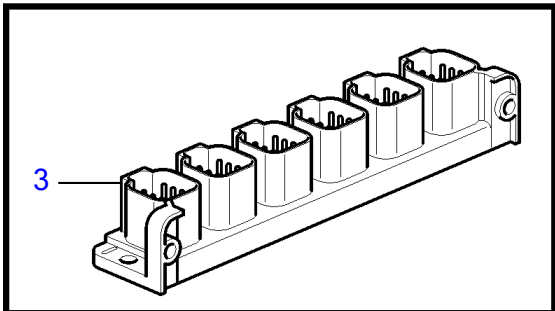
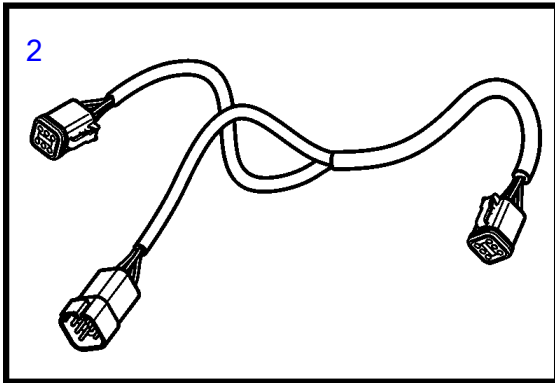
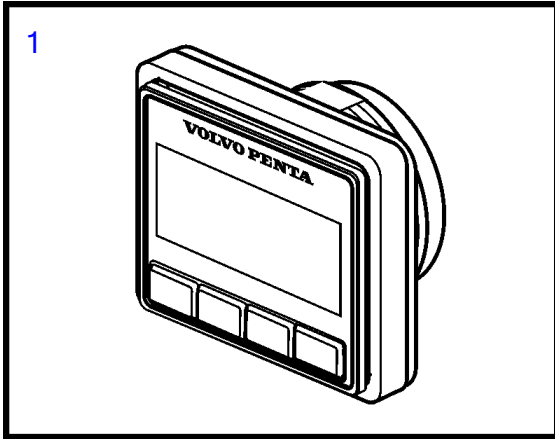

D6-330D-F, D6-370D-F, D6-435D-F

REF	PART NO.	QTY	DESCRIPTION	NOTES
1	21846926	1	Display panel	
2	3588972	3	Cable kit	
3	21469055	2	Connection block	
4	3886666	7	Cable	
5	21581323	1	Steering wheel adjus	
6	21469560	1	Steering wheel hub	
7	21421941	2	Cable	For EVC system and hub 21469560.
8	21287072	1	Wiring harness	
9	21427460	1	Cable	
10	21450563	2	Cable	
11	977184	1	• Housing	
12	873765	1	Relay	12V
	3171420	1	Relay	24V