

D6-300A-F, D6-300I-F, D6-330A-F, D6-330D-F, D6-330I-F, D6-370A-F, D6-370D-F, D6-370I-F, D6-400A-F, D6-435D-F, D6-435I-WJ-F

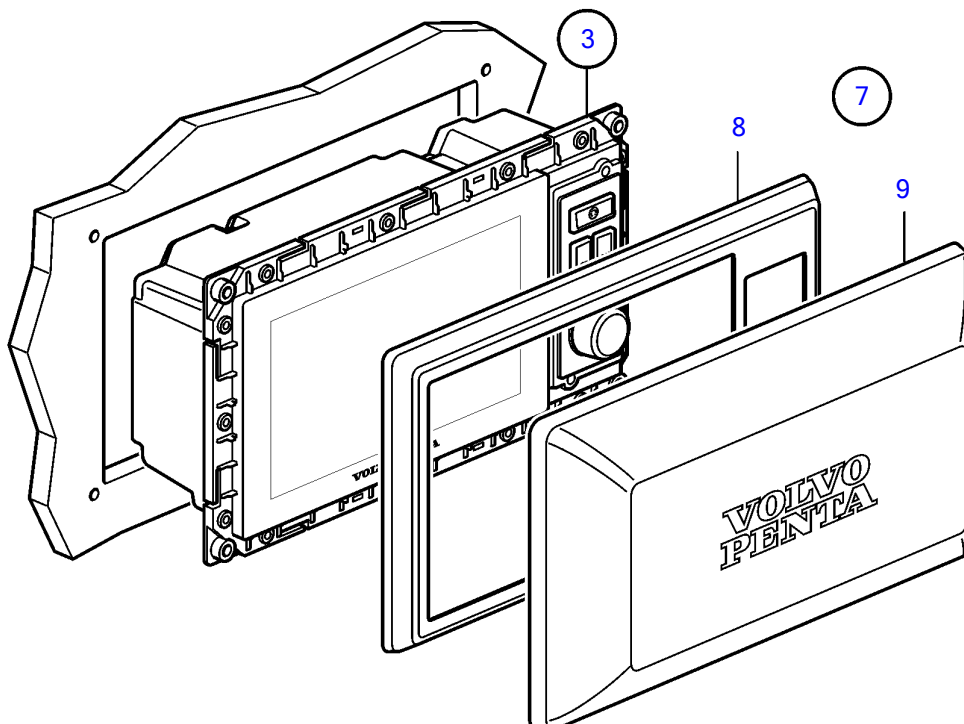
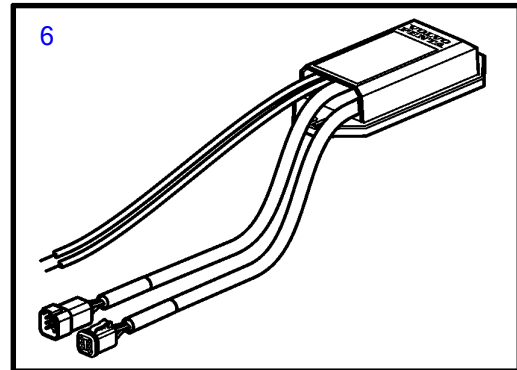
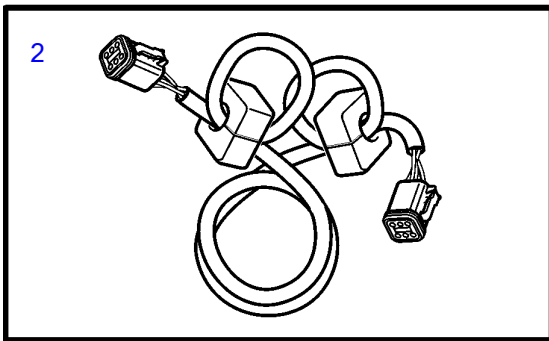
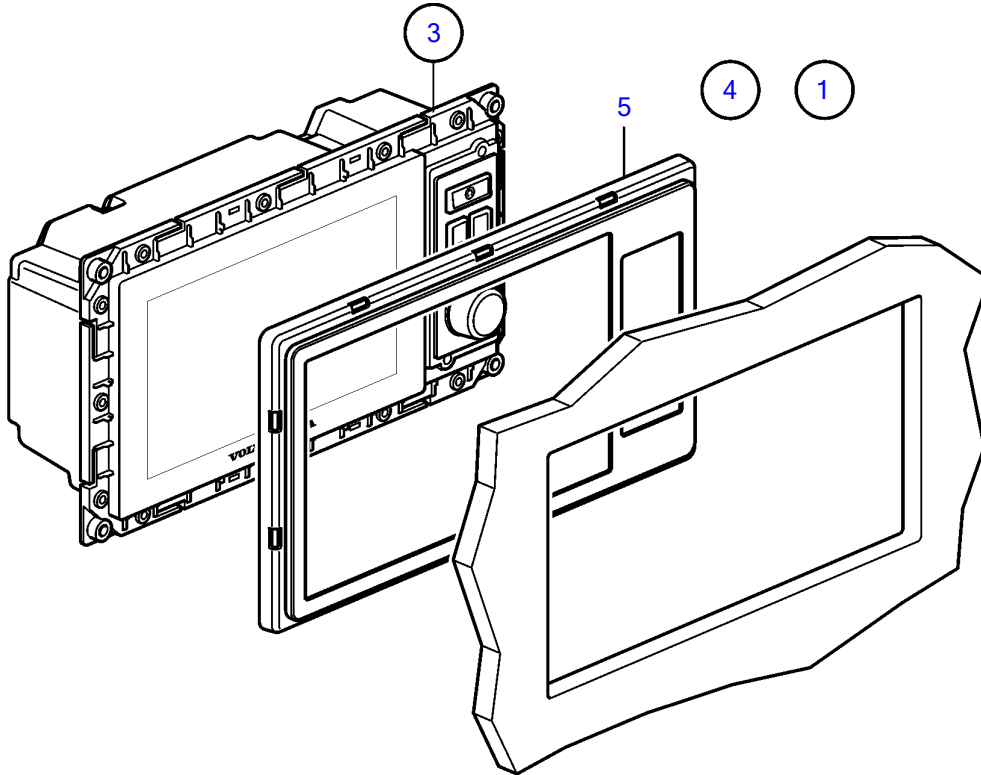

D6-300A-F, D6-300I-F, D6-330A-F, D6-330D-F, D6-330I-F, D6-370A-F, D6-370D-F, D6-370I-F, D6-400A-F, D6-435D-F, D6-435I-WJ-F

REF	PART NO.	QTY	DESCRIPTION	NOTES
1	22080260	1	Display	For flush mounting.
2	21514712	1	• Cable	
3		1	• Kit	
		1	• • Display	
4	21330288	1	Frame	For flush mounting.
5		1	Frame	
6	21379779	1	Network adapter	12V
7	21330289	1	Frame	For top mounting
8	(21143284)	1	• Frame	Obsolete part, For top mounting
9	21144292	1	• Cover	