

D6-310D-E, D6-330D-E, D6-370D-E, D6-435D-E

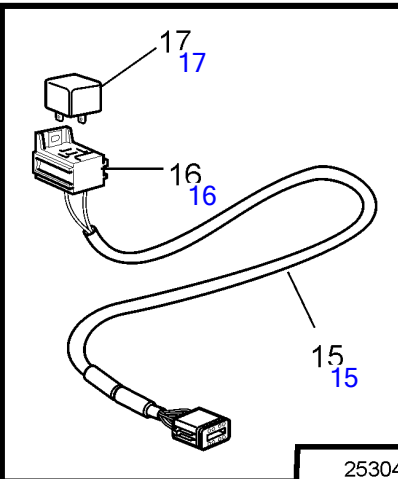
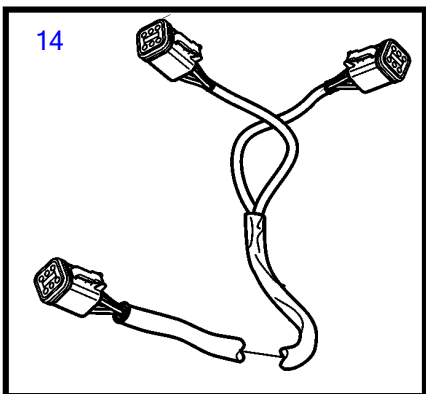
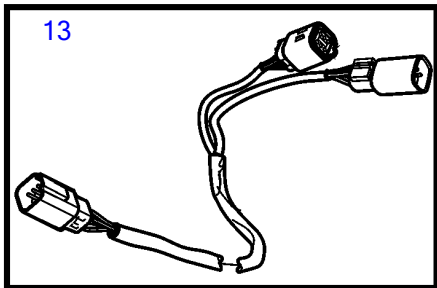
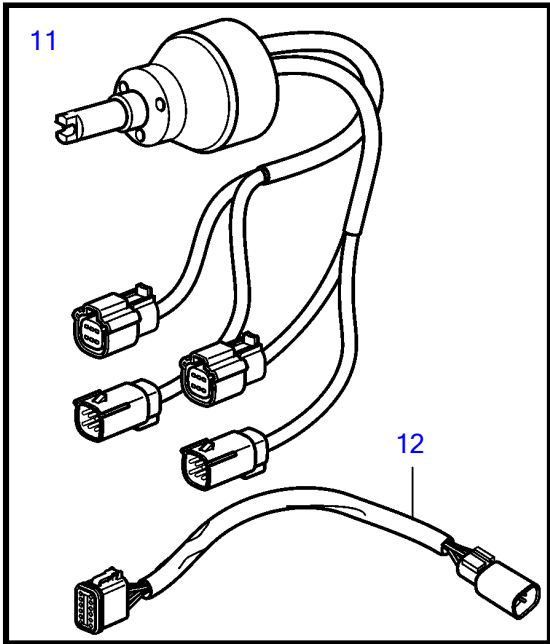
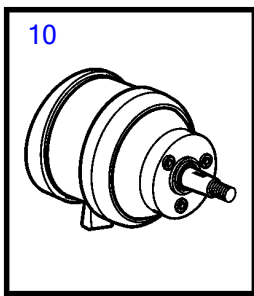
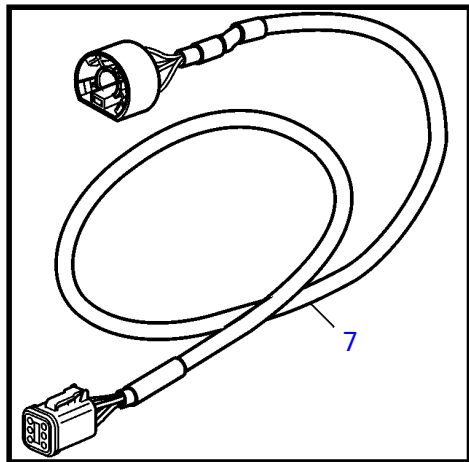
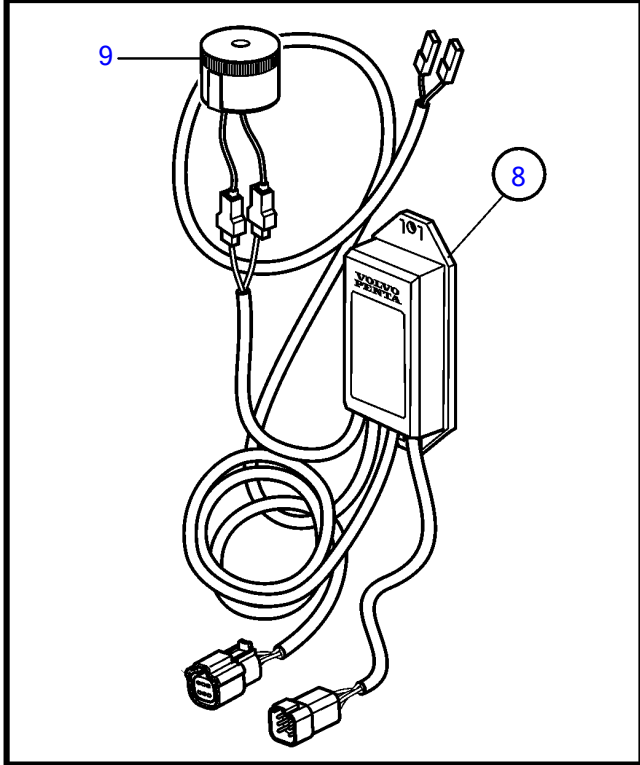
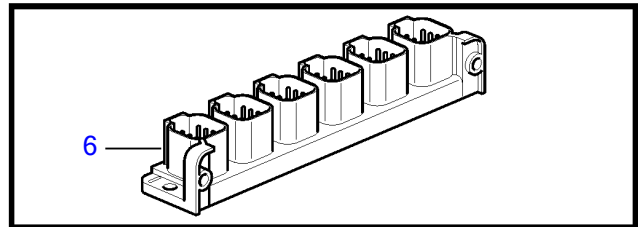
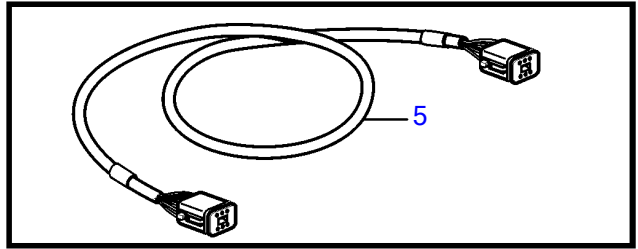
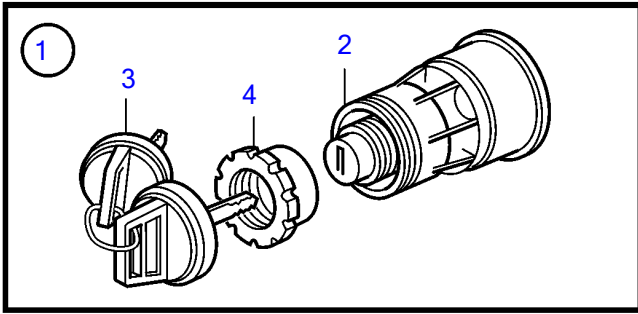

25304

D6-310D-E, D6-330D-E, D6-370D-E, D6-435D-E

REF	PART NO.	QTY	DESCRIPTION	SEE SEC.	NOTES
1	3587070	2	Starter switch		
2	3587071	1	• Starter switch		
3	859955	1	• • Plastic nut		
4	859953	1	• • Key		State key code when ordering
			• Bulletin 49-30	49-30-EN	Key P/N 859953
5	3886666	9	Cable		
6	21469055	2	Connection block		
7	881849	4	Wiring harness		
8	21461496	4	Network adapter		Analogue key interface
9	3817974	1	• Alarm		
10	3841280	1	Steering wheel adjus		
11	21469560	1	Steering wheel hub		
12	21421942	1	Cable		Alternative for EVC-C3
13	21421941	2	Cable		For EVC system and hub 21469560.
14	21287072	1	Wiring harness		
15	21450563	2	Cable		
16	977184	1	• Housing		
17	873765	1	Relay		12V
	3171420	1	Relay		24V

7746210-64-36161

25304

Upd:2014-07-03