

D7C-A TA

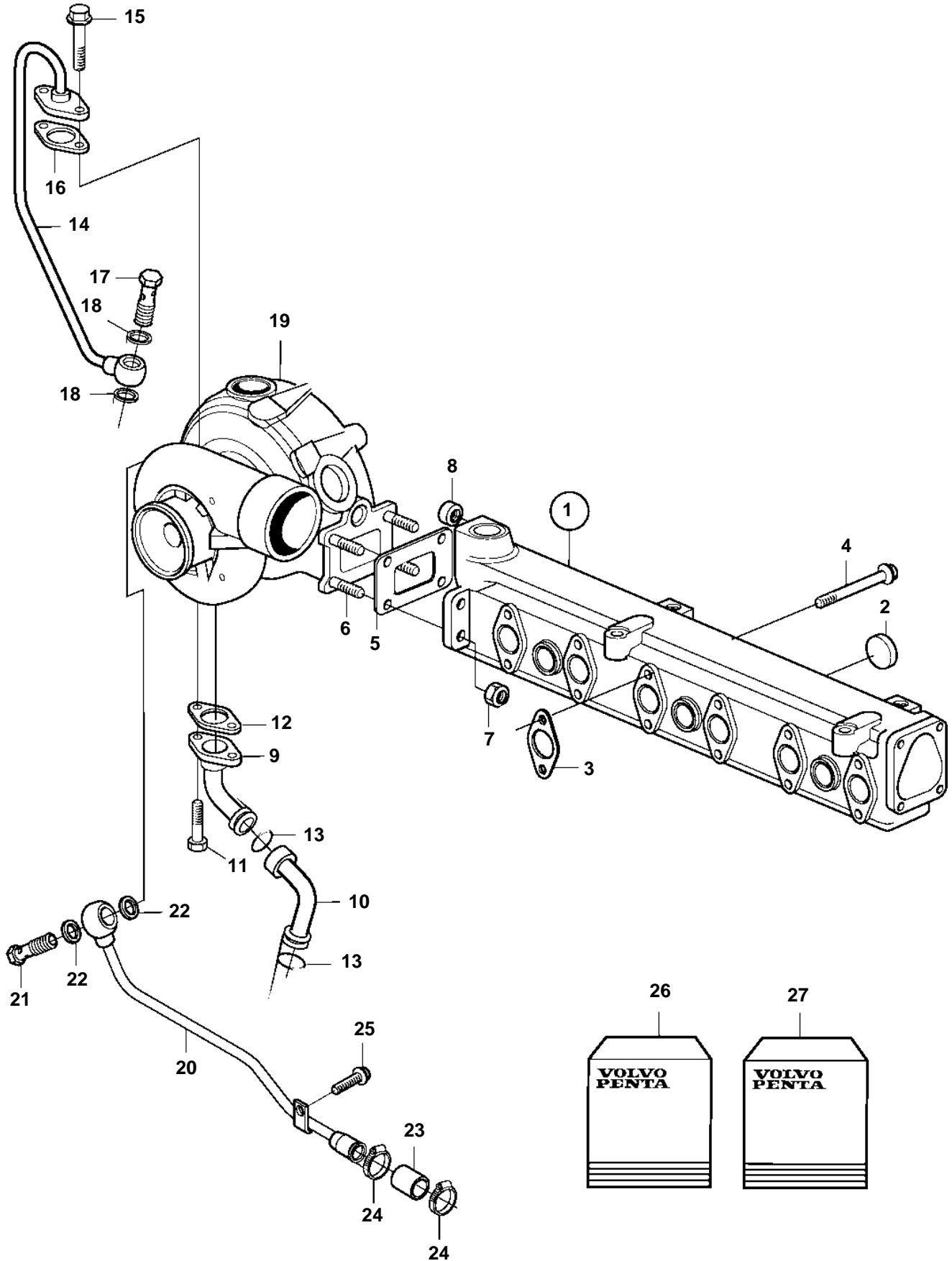

D7C-A TA

REF	PART NO.	QTY	DESCRIPTION	NOTES
1		1	Exhaust manifold	3587175. For spare part take 3587175
2	20412745	10	· Plug	
3	20405589	6	Gasket	
4	888783	12	Screw	
5	888784	1	Gasket	
6	888785	4	Stud	
7	20412308	4	Nut	
8	888786	1	Sealing ring	
9	888730	1	Oil line	
10	888731	1	Oil line	
11	946173	2	Flange screw	
12	20405790	1	Gasket	
13	20405822	2	O-ring	
14	888744	1	Oil line	
15	946173	2	Flange screw	
16	20405595	1	Gasket	
17	25167	1	Hollow screw	
18	969011	2	Gasket	
19	888789	1	Turbo	
			Comps. not spec.	
20	888815	1	Water pipe	
21	20460398	1	Hollow screw	
22	947628	1	Gasket	
23	888816	1	Rubber sleeve	
24	853548	2	Hose clamp	
25	20460023	1	Screw	
26	3587655	1	Gasket kit, inlet/exhaust	SEE GROUP 99
27	3587656	1	Gasket kit, connection, turbo	SEE GROUP 99