

D49A-MT AUX, , D49A-MS AUX

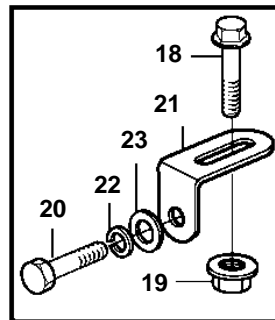
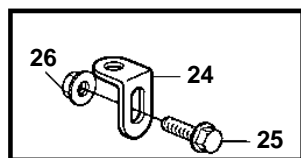
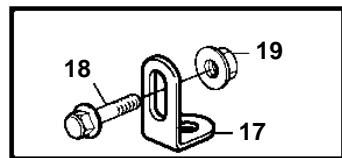
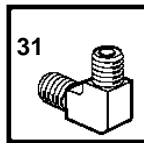
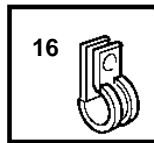
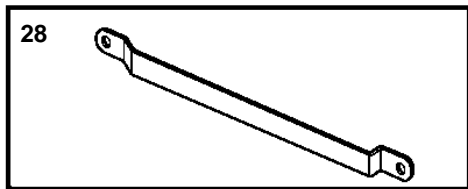
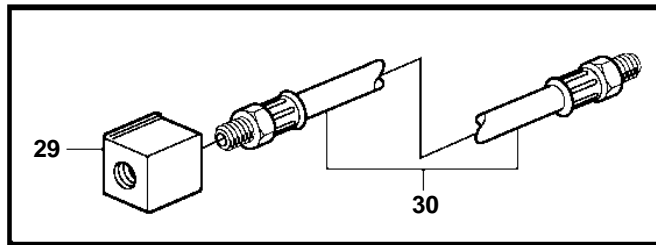
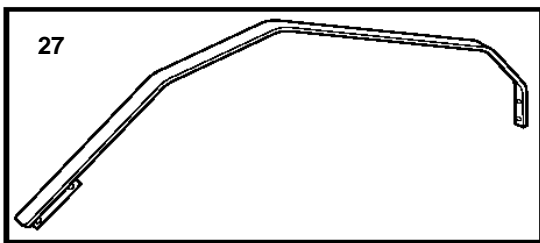
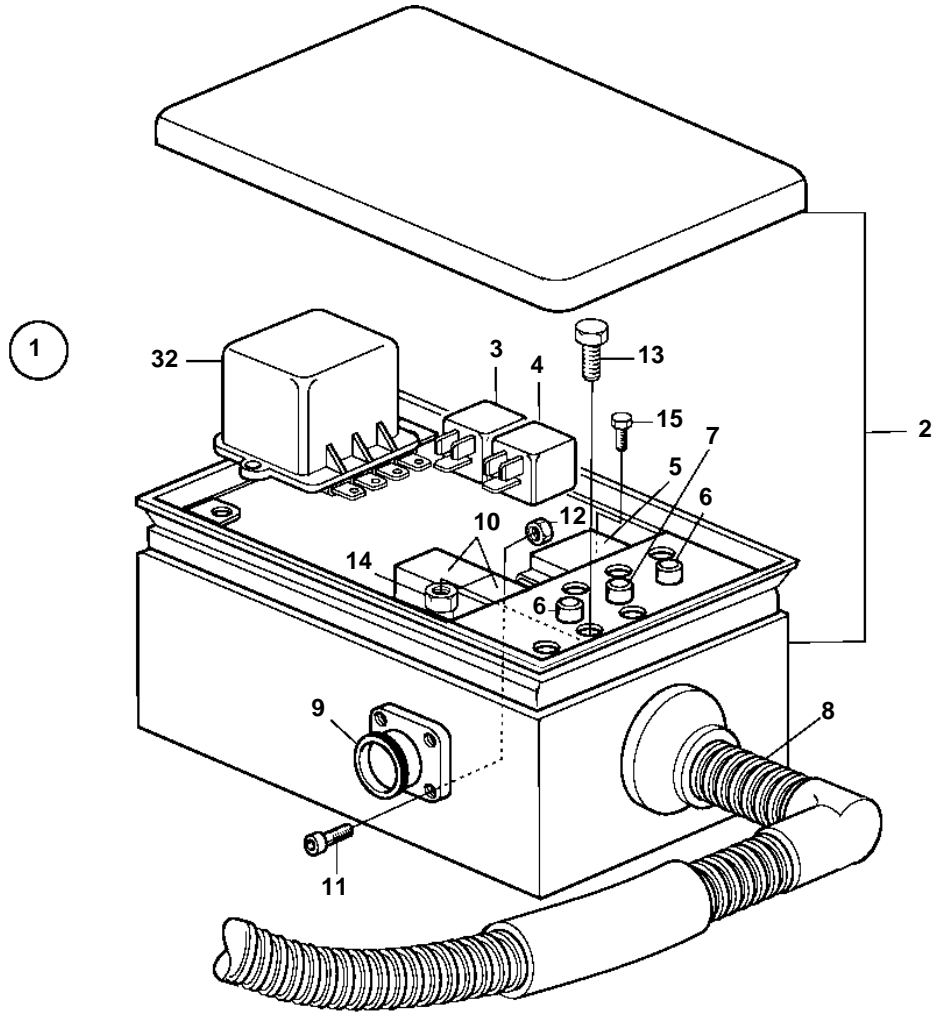

20344

D49A-MT AUX, , D49A-MS AUX

REF	PART NO.	QTY	DESCRIPTION	NOTES
1		1	Wiring harness	
2	3832498	1	• Box	
3	20374662	1	• Relay	
4	20374662	1	• Relay	
5	874100	1	• Timer relay	
6	846611	1	• Sleeve connector	
7	873952	2	• Fuse	
8	874579	1	• Fuse	
9	977184	2	• Tab housing	
10	874306	1	• Wiring harness	
11		4	Screw	
12	955778	4	Nut	
13	969408	6	Screw	
14	963104	6	Nut	
15	956074	4	Screw	
16	947827	6	Clamp	D=25,4mm
	945081	3	Clamp	D=22,2mm
	949747	1	Clamp	D=15,9mm
17	965553	3	Bracket, fuel inj. pump	L=40mm
	3836040	1	Bracket, adapter	
	3836043	1	Bracket	
18	946440	3	Flange screw	M8
19	945408	3	Flange nut	M8
20	3832042	1	Screw, fuel filter	M10
21	965553	1	Bracket, fuel inj. pump	
22	3832233	1	Spring washer, fuel filter	
23	3832214	1	Washer, fuel filter	
24	965557	5	Bracket	Main Cable, insp. Covers
25	946440	3	Flange screw	
26	945408	5	Flange nut	
27	3836039	1	Bracket	Flywheel house, from side to side
28	3836041	1	Bracket	Main Cable, insp. Covers
29	3836042	1	Bracket, turbo pressure sender	
30	3826006	1	Hose, turbo pressure sender	
31	957107	1	Elbow nipple, turbo pressure hose	
32	3836429	1	Starter relay, starter motor	