

D34A-MT, D34A-MS

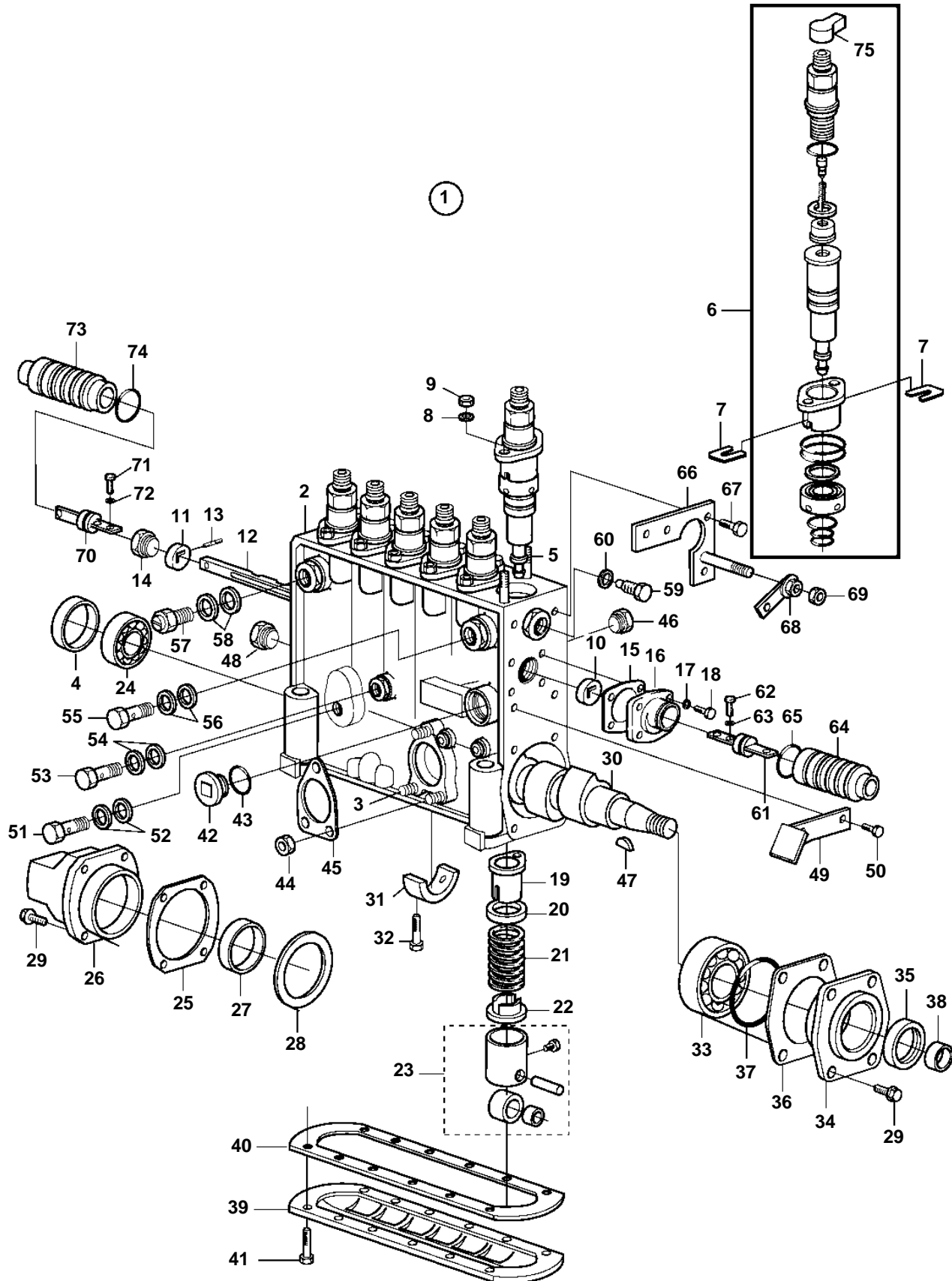

D34A-MT, D34A-MS

REF	PART NO.	QTY	DESCRIPTION	NOTES
1		1	Injection pump	
2	3833635	1	· Housing	
3	3834739	3	· Stud	
4	3834342	1	· Ring	
5	3834745	12	· Stud	
6	3832183	6	· Pump element	
7	3834526	X	· Shim	TH=0,500mm
	3834527	X	· Shim	TH=0,525mm
	3834528	X	· Shim	TH=0,550mm
	3834529	X	· Shim	TH=0,575mm
	3834530	X	· Shim	TH=0,600mm
	3834531	X	· Shim	TH=0,625mm
	3834532	X	· Shim	TH=0,650mm
	3834533	X	· Shim	TH=0,675mm
	3834534	X	· Shim	TH=0,700mm
	3834535	X	· Shim	TH=0,725mm
	3834536	X	· Shim	TH=0,750mm
	3834537	X	· Shim	TH=0,775mm
	3834538	X	· Shim	TH=0,800mm
	3834539	X	· Shim	TH=0,825mm
	3834540	X	· Shim	TH=0,850mm
	3834541	X	· Shim	TH=0,875mm
	3834542	X	· Shim	TH=0,900mm
	3834543	X	· Shim	TH=0,925mm
	3834544	X	· Shim	TH=0,950mm
	3834545	X	· Shim	TH=0,975mm
	3834546	X	· Shim	TH=1,000mm
	3834547	X	· Shim	TH=1,025mm
	3834548	X	· Shim	TH=1,050mm
	3834549	X	· Shim	TH=1,075mm
	3834550	X	· Shim	TH=1,100mm
	3834551	X	· Shim	TH=1,125mm
	3834552	X	· Shim	TH=1,150mm
	3834553	X	· Shim	TH=1,175mm
	3834554	X	· Shim	TH=1,200mm
	3834555	X	· Shim	TH=1,225mm
	3834556	X	· Shim	TH=1,250mm
	3834557	X	· Shim	TH=1,275mm
	3834558	X	· Shim	TH=1,300mm
	3834559	X	· Shim	TH=1,325mm
	3834560	X	· Shim	TH=1,350mm
	3834561	X	· Shim	TH=1,375mm
	3834562	X	· Shim	TH=1,400mm
	3834563	X	· Shim	TH=1,425mm
	3834564	X	· Shim	TH=1,450mm
	3834565	X	· Shim	TH=1,475mm
	3834566	X	· Shim	TH=1,500mm
	3834567	X	· Shim	TH=1,525mm
	3834568	X	· Shim	TH=1,550mm
	3834569	X	· Shim	TH=1,575mm
	3834570	X	· Shim	TH=1,600mm
	3834571	X	· Shim	TH = 1,625mm
	3834572	X	· Shim	TH=1,650mm
	3834573	X	· Shim	TH=1,675mm
	3834574	X	· Shim	TH=1,700mm
	3834575	X	· Shim	TH=1,725mm
	3834576	X	· Shim	TH=1,750mm
	3834577	X	· Shim	TH=1,775mm
	3834578	X	· Shim	TH=1,800mm
	3834579	X	· Shim	TH=1,825mm
	3834580	X	· Shim	TH=1,850mm
	3834581	X	· Shim	TH=1,875mm
	3834582	X	· Shim	TH=1,900mm

D34A-MT, D34A-MS

REF	PART NO.	QTY	DESCRIPTION	NOTES
7	3834583	X	· Shim	TH=1,925mm
	3834584	X	· Shim	TH=1,950mm
	3834585	X	· Shim	TH=1,975mm
8	3834849	12	· Washer	
9	3833800	12	· Nut	
10	3833080	1	· Bushing	
11	3833079	1	· Bushing	
12	3837809	1	· Rack	
13	3833955	1	· Pin	
14	3833242	1	· Connector	
15	3833516	1	· Gasket	
16	3837795	1	· Adapter	
17	3834890	4	· Spring washer	
18	3834406	4	· Screw	
19	3834604	6	· Control sleeve	
20	3834483	6	· Seat	
21	3834643	6	· Spring	
22	3834484	6	· Seat	
23	3834763	6	· Tappet	
24	3832160	1	· Bearing	
25	3833515	1	· Gasket	
26	3833315	1	· Cover	
27	3834444	1	· Sealing ring	
28	3834518	X	· Shim	TH=0,600mm
	3834514	X	· Shim	TH=1,200mm
	3834515	X	· Shim	TH = 1,500mm
	3834516	X	· Shim	TH=1,800mm
	3834517	X	· Shim	TH=2,000mm
29	3832195	8	· Screw	
30	3833098	1	· Camshaft	
31	3832167	1	· Bearing	
32	3832194	2	· Screw	
33	3832160	1	· Bearing	
34	3833316	1	· Cover	
35	3834446	1	· Sealing ring	
36	3834519	X	· Shim	TH=0,100mm
	3834520	X	· Shim	TH=0,120mm
	3834521	X	· Shim	TH=0,140mm
	3834522	X	· Shim	TH=0,160mm
	3834523	X	· Shim	
	3834524	X	· Shim	TH=0,300mm
	3834525	X	· Shim	TH=0,500mm
37	3833831	1	· O-ring	
38	3834601	1	· Sleeve	
39	3833314	1	· Cover	
40	3833514	1	· Gasket	
41	3834407	12	· Screw	
42	3834258	1	· Plug	
43	3833502	1	· Gasket	
44	3833805	3	· Nut	
45	3837801	1	· Gasket	
46	3834259	6	· Plug	
47	3833689	1	· Woodruff key	
48	3834257	1	· Plug	
49	3834288	1	· Setting indicator	
50	3832193	2	· Screw	
51	3832275	1	· Hollow screw	
52	3831591	2	· Sealing washer	
53	3832276	1	· Hollow screw	
54	3833509	2	· Gasket	
55	3832274	1	· Hollow screw	
56	3831591	2	· Sealing washer	
57	3834839	1	· Overflow valve	

D34A-MT, D34A-MS

REF	PART NO.	QTY	DESCRIPTION	NOTES
58	3831591	2	· Sealing washer	
59	3832235	1	· Screw	
60	3837802	1	· Gasket	
61	3837821	1	· Connector	
62	3837805	2	· Screw	
63	3834891	2	· Spring washer	
64	3837806	1	· Cover	
65	3833830	1	· O-ring	
66	3832997	1	· Bracket	
67	3832236	1	· Screw	
68	3834202	1	· Plate	
69	3833806	1	· Nut	
70	3837825	1	· Connector	
71	3837805	2	· Screw	
72	3834891	2	· Spring washer	
73	3837806	1	· Cover	
74	3833830	1	· O-ring	
75	3839517	1	· Cap	