

D25A-MT AUX, D25A-MS AUX, D30A-MT AUX, D30A-MS AUX

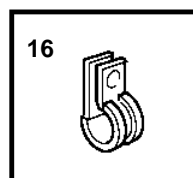
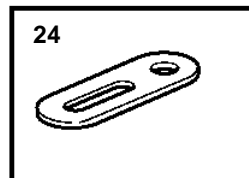
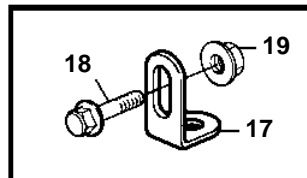
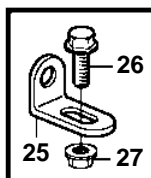
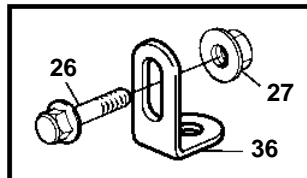
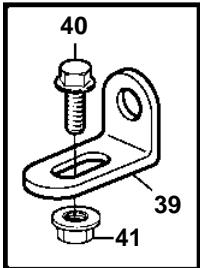
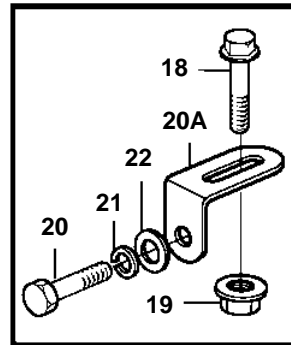
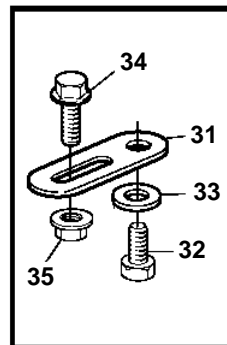
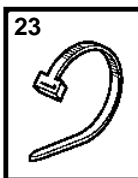
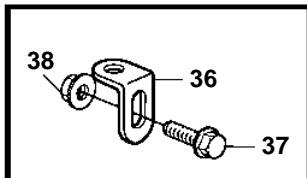
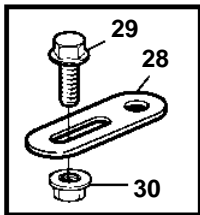
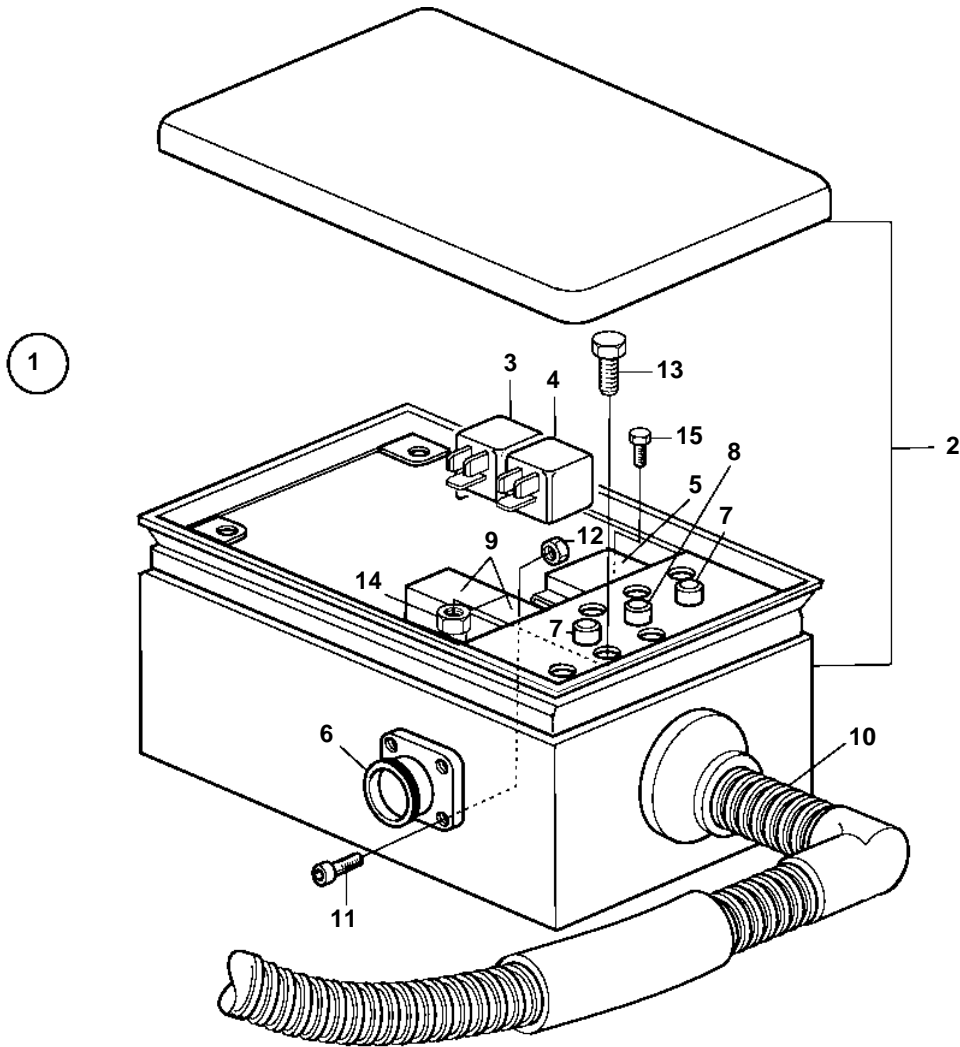

D25A-MT AUX, D25A-MS AUX, D30A-MT AUX, D30A-MS AUX

| REF | PART NO. | QTY | DESCRIPTION | NOTES |
|-----|----------|-----|-------------------------------------|--------------------------------------------|
| 1 | | 1 | Wiring harness | |
| 2 | 3832498 | 1 | • Box | |
| 3 | 3171420 | 1 | • Relay | |
| 4 | 3171420 | 1 | • Relay | |
| 5 | 874100 | 1 | • Timer relay | |
| 6 | 846611 | 1 | • Sleeve connector | |
| 7 | 873952 | 2 | • Fuse | |
| 8 | 874579 | 1 | • Fuse | |
| 9 | 977184 | 2 | • Tab housing | |
| 10 | 874305 | 1 | • Wiring harness | |
| 11 | 956046 | 4 | • Screw | |
| 12 | 955778 | 4 | • Nut | |
| 13 | 969408 | 6 | • Screw | (956079) |
| 14 | 963104 | 6 | • Nut | |
| 15 | 956074 | 4 | • Screw | |
| 16 | 947827 | 3 | Clamp | D=25,4mm |
| | 949747 | 3 | Clamp | D=15,9mm |
| | 949746 | 3 | Clamp | D=12,7mm |
| | 945081 | 4 | Clamp | D=22,2mm |
| 17 | 965553 | 2 | Bracket, cooling water temp sensor | L=40mm |
| 18 | 946440 | 3 | Flange screw | M8 |
| 19 | 945408 | 3 | Flange nut | M8 |
| 20 | 3832042 | 1 | Screw, clamp, stop solenoid | M10 |
| 20A | 965553 | 1 | Bracket, clamp, stop solenoid | |
| 21 | 3832233 | 1 | Spring washer, clamp, stop solenoid | |
| 22 | 3832214 | 1 | Washer, clamp, stop solenoid | |
| 23 | 948211 | 2 | Strip clamp | D=67mm, L=270mm |
| | 948702 | 3 | Strip clamp | D=15mm, L=95mm |
| | 948616 | 6 | Strip clamp | D=85mm, L=375mm |
| | 948702 | 3 | Strip clamp | D=15mm, L=95mm |
| 24 | 3836034 | 1 | Bracket | |
| 25 | 965557 | 1 | Bracket, cable, turbopress. sensor | |
| 26 | 946440 | 2 | Flange screw | |
| 27 | 945408 | 2 | Flange nut | |
| 28 | 965536 | 1 | Bracket, main cable | |
| 29 | 946440 | 1 | Flange screw | |
| 30 | 945408 | 1 | Flange nut | |
| 31 | 965536 | 1 | Bracket, cable, oil pressure | |
| 32 | 3835725 | 1 | Screw | |
| 33 | 3832245 | 1 | Spring washer | |
| 34 | 946440 | 1 | Flange screw | |
| 35 | 945408 | 1 | Flange nut | |
| 36 | 965557 | 2 | Bracket | Cable, water temp and oil pressure sensor. |
| 37 | 946440 | 2 | Flange screw | |
| 38 | 945408 | 2 | Flange nut | |
| 39 | | 1 | Bracket | |
| 40 | 946440 | 1 | Flange screw | |
| 41 | 945408 | 1 | Flange nut | |