

D2-55A, D2-55B, D2-55C, D2-55D, D2-55E, D2-55F

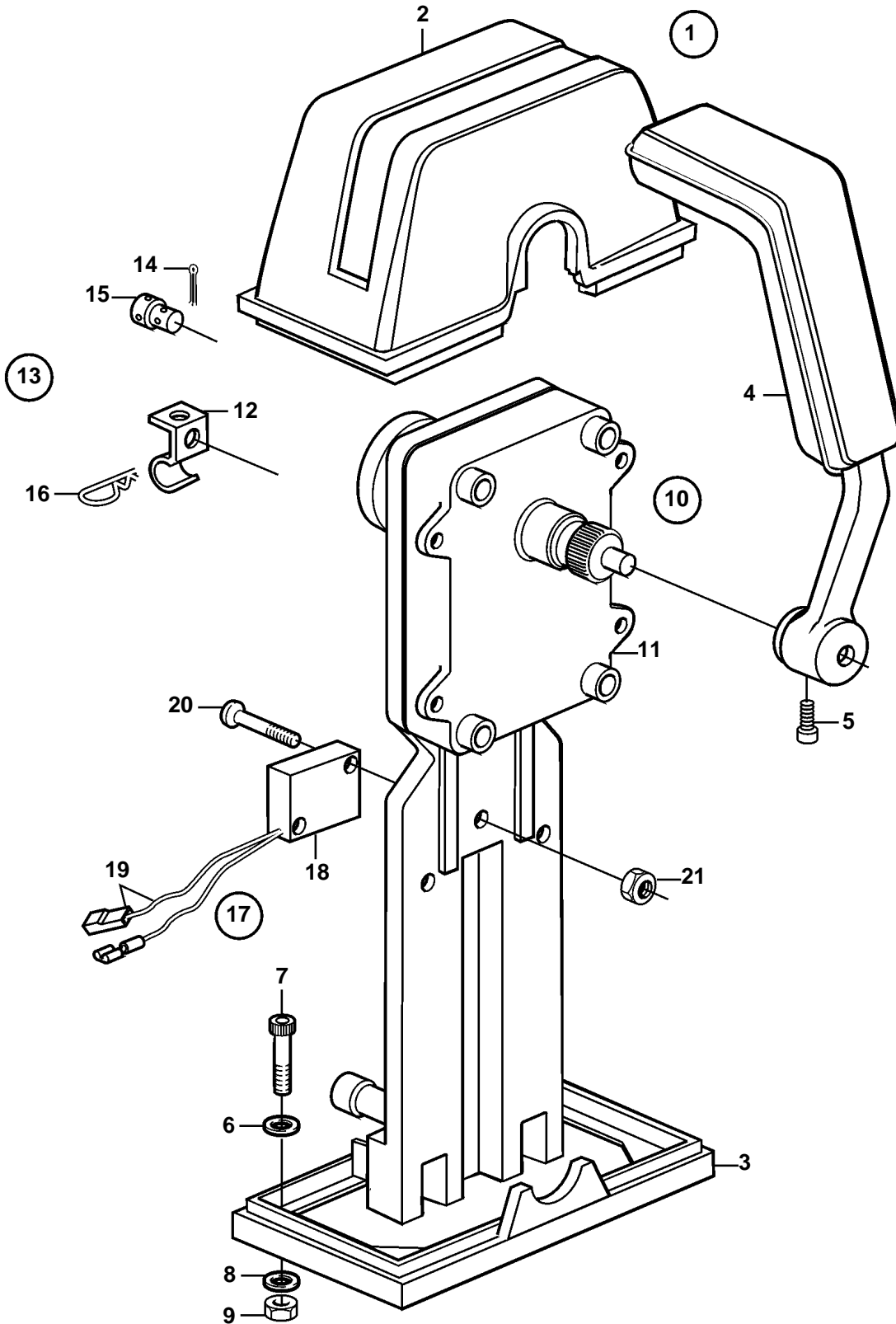

D2-55A, D2-55B, D2-55C, D2-55D, D2-55E, D2-55F

REF	PART NO.	QTY	DESCRIPTION	SEE SEC.	NOTES
1	851602	1	Mounting kit		
2	850823	1	· Cover		(839472)
3	839474	1	· Plate		
4	839475	1	· Hand lever		
5	839693	1	· Lock screw		
6	940090	2	· Washer		
7	947671	4	· Hex. socket screw		
8	960138	4	· Washer		
9	955780	4	· Hexagon nut		
10	851600	1	Control		
11		1	· Control mechanism		
12	853423	1	· Retainer		
13		1	· Connector kit		
14	17253	2	· · Split pin		
15	839638	2	· · Cube		
16	852924	1	· · Clip		
17	855352	1	Neutral position con		
18	850200	1	· Toggle switch		
19		X	· · Cables and terminals	1963	
20	946177	2	· Cross recessed screw		
21	947536	2	· Hexagon nut		