

D12D-B MP

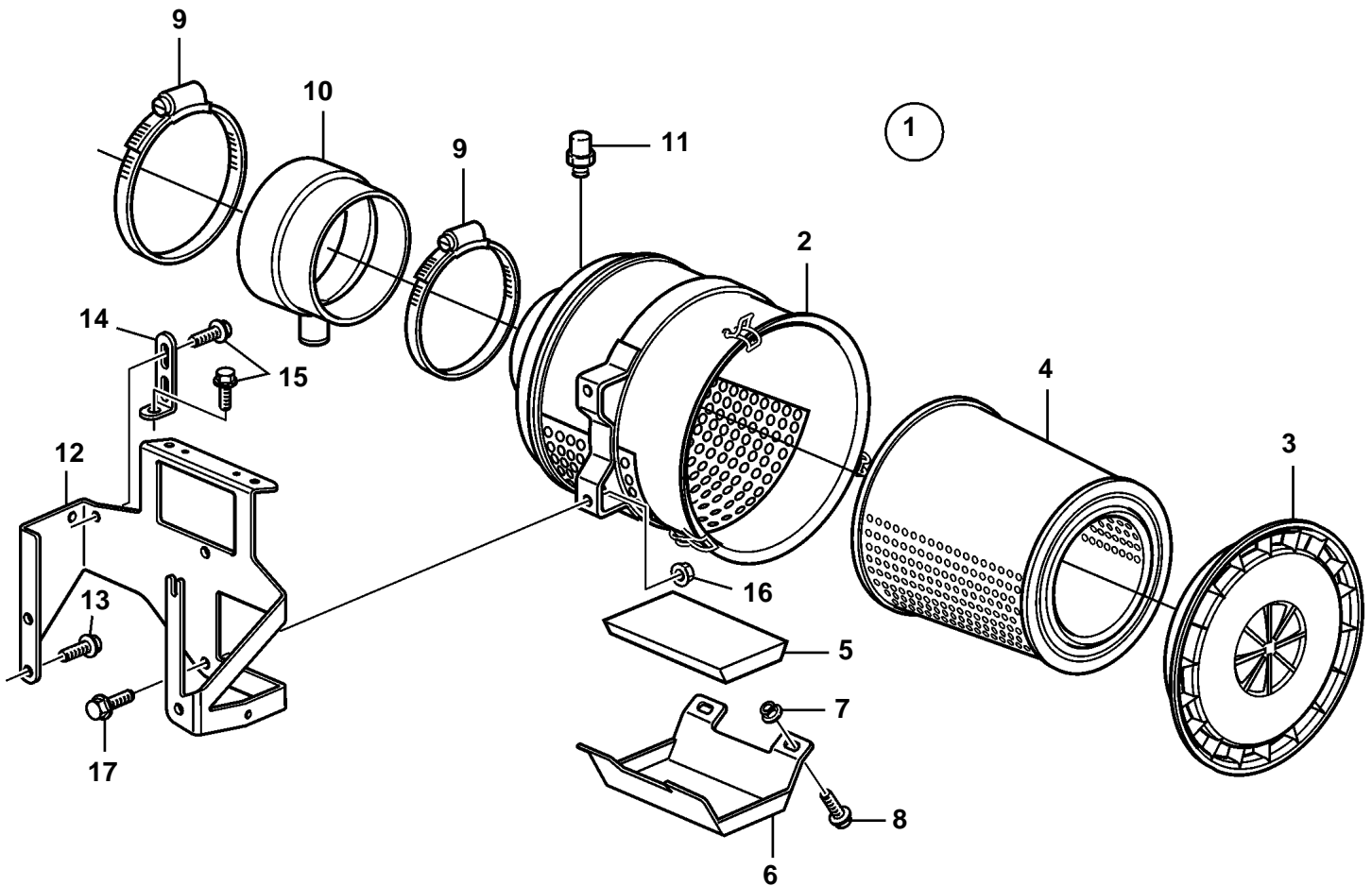

21384

D12D-B MP

REF	PART NO.	QTY	DESCRIPTION	NOTES
1	3828568	1	Air filter	EARLY TYPE
2		1	· Filter housing	
3		1	· Lock	
4	3828811	1	· Filter insert	
5	3830197	1	Oil collector	
6	3830166	1	Oil trap	
7	963105	4	Lock nut	
8	967949	4	Flange screw	
9	961907	2	Hose clamp	
10	3588022	1	Rubber collar	
11	3828765	1	Pressure drop indica	(842037)
12	3818425	1	Bracket	
13	946472	2	Flange screw	
14	965562	1	Bracket	
15	946440	2	Flange screw	
16	945408	2	Flange nut	
17	946173	2	Flange screw	