

D1-30A, D1-30B, D2-40A, D2-40B, D1-30F, D2-40F

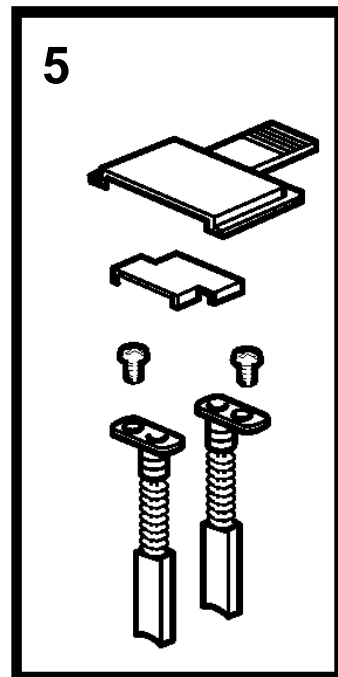
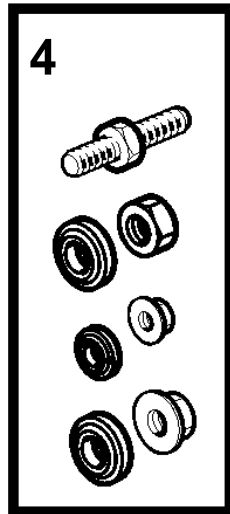
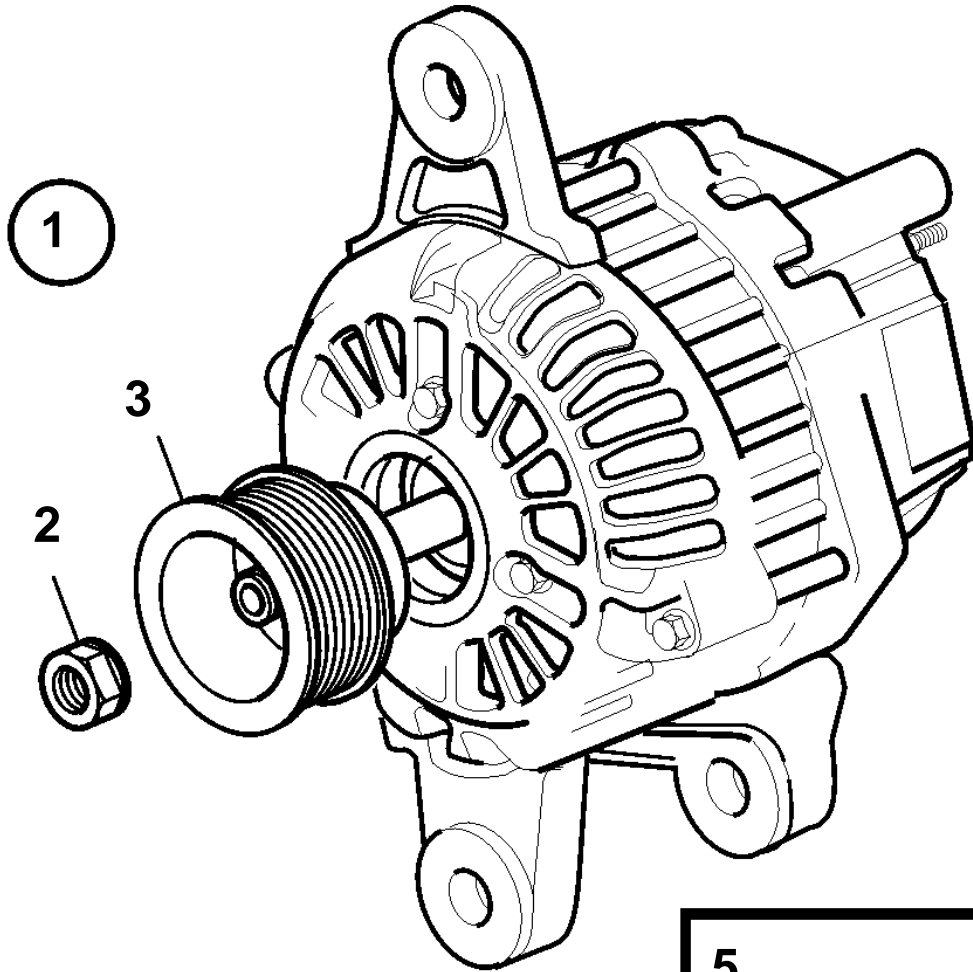

D1-30A, D1-30B, D2-40A, D2-40B, D1-30F, D2-40F

REF	PART NO.	QTY	DESCRIPTION
1	3803650	1	Alternator, exch
2	3818955	1	· Nut set
3	3818957	1	· Pulley
4	3818997	1	· Connector kit
5	3818999	1	· Brush set