

D1-20

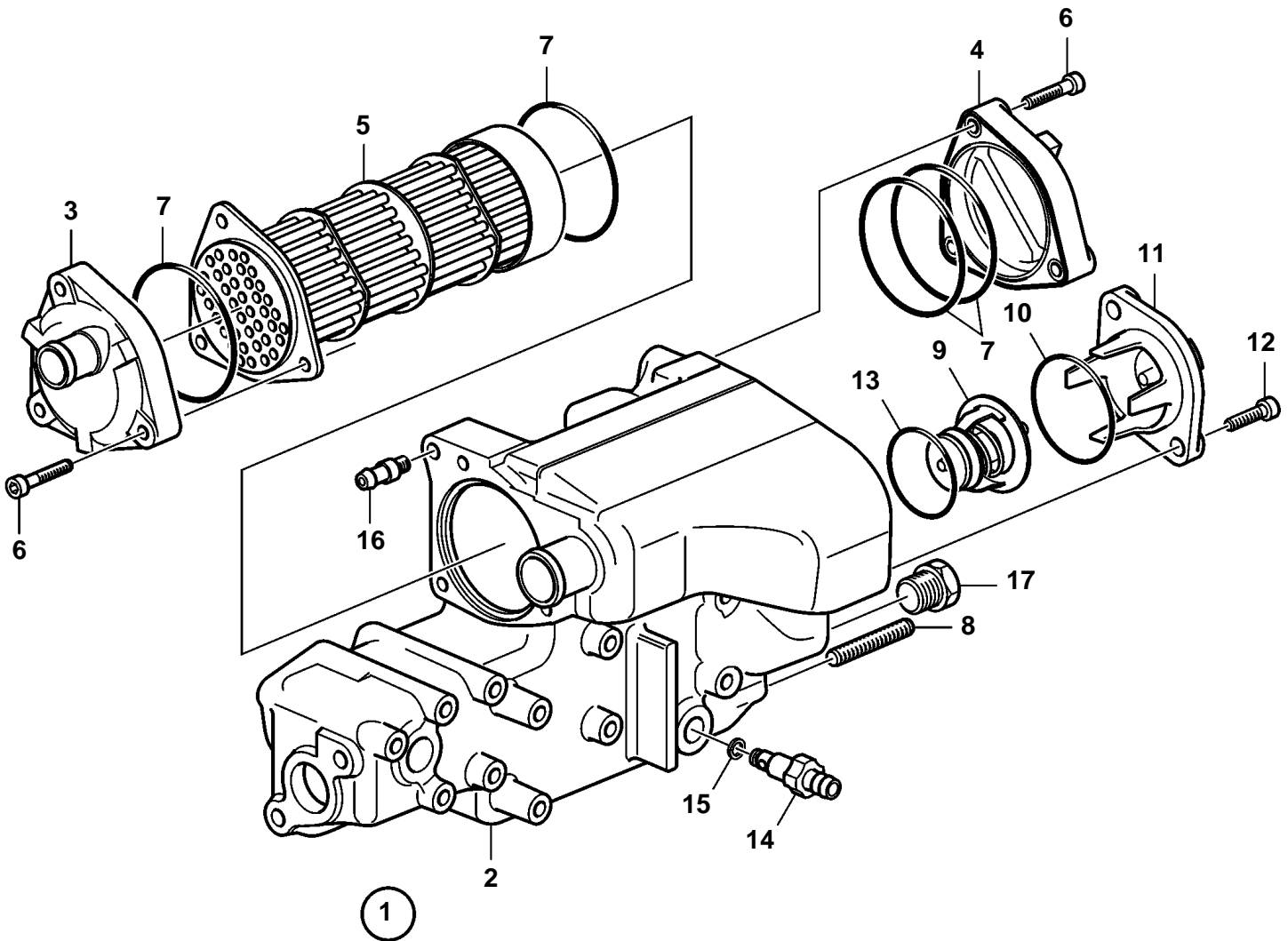

22994

D1-20

REF	PART NO.	QTY	DESCRIPTION
1	3840128	1	Heat exchanger
2		1	· Heat exchanger housi
3	3842022	1	· End cover
4	3842021	1	· End cover
5	3842018	1	· Insert
6	959207	6	· Screw
7	3842016	4	· O-ring
8	3584203	4	· Stud
9	3842015	1	· Thermostat
10	3583830	1	· O-ring
11	888622	1	· Cover
12	959222	2	· Screw
13	3586514	1	· O-ring
14	3583822	1	· Draining nippel
15		1	· · O-ring
16	3842014	1	· Tube
17	982364	1	· Plug