

AD31L-A, AD31P-A, AD41L-A, AD41P-A, D41L-A, TAMD31L-A, TAMD31M-A, TAMD31P-A, TAMD31S-A, TAMD41H-A, TAMD41H-B, TAMD41P-A, TAMD41L-A, TAMD41M-A, TMD31L-A, TMD41L-A

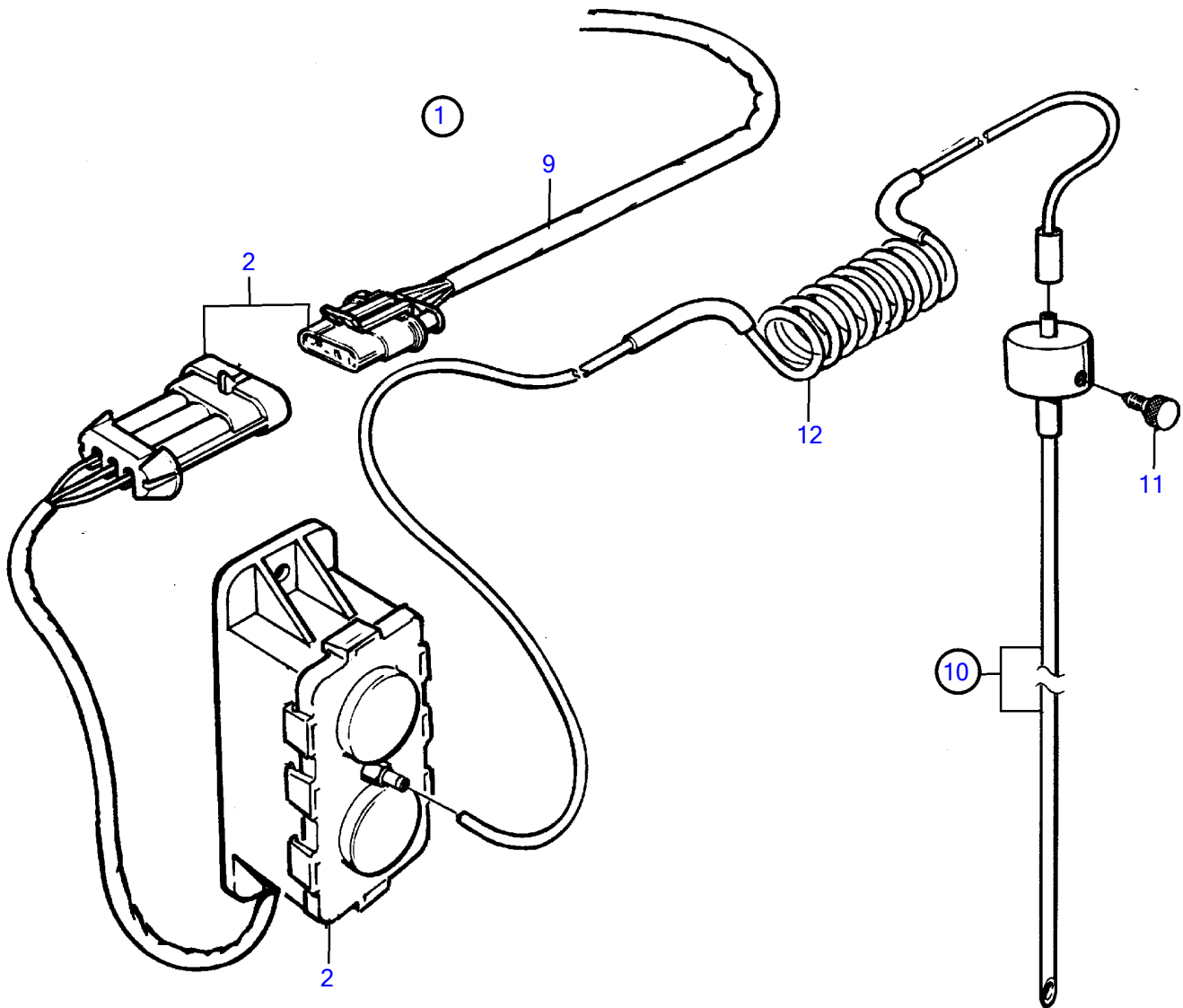
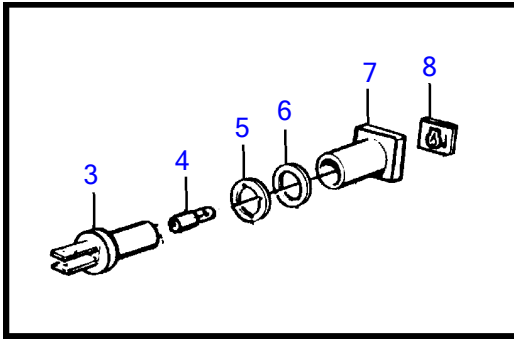

AD31L-A, AD31P-A, AD41L-A, AD41P-A, D41L-A, TAMD31L-A, TAMD31M-A, TAMD31P-A, TAMD31S-A, TAMD41H-A, TAMD41H-B, TAMD41P-A, TAMD41L-A, TAMD41M-A, TMD31L-A, TMD41L-A

REF	PART NO.	QTY	DESCRIPTION	SEE SEC.	NOTES
1	(866854)	1	Oil level sensor		12V, Obsolete part
2	(866831)	1	• Electronic unit		Obsolete part
3	808175	1	• Lamp socket		
4	19923	1	• Bulb		12V
5	967583	1	• Retainer		
6	829714	1	• Sealing ring		
7	838455	1	• Retainer		
8	866853	1	• Symbol strip		
9		X	cables and terminals	1963	
10	(866841)	1	Dipstick		Obsolete part
11		1	• Screw		
12		1	• Hose		